



Web server

Synco™, Synco™ living

OZW772...
V2.0

The OZW772 web server allows for remote operation and monitoring of plants via the web and send faults and system reports to e-mail recipients.

- Operate web browser via PC/laptop and Smartphone
- Operate ACS (PC/laptop with ACS plant operating software)
- Local connection via USB
- Remote connection via Ethernet (DSL router)
- Operate and monitor via customized plant diagrams
- User accounts for web operation (user groups, operating language)
- Simultaneously support multiple users
- Display fault messages in the web browser
- Send fault messages to a maximum of 4 e-mail recipients
- Periodically send system reports to e-mail recipients
- Save the last 500 faults and messages (history)
- Direct commissioning with web browser or ACS service tool
- Software update via USB connection

Web servers OZW772.01, OZW772.04, OZW772.16, OZW772.64 can connect 1, 4, 16, or 64 KNX devices from the product ranges Synco 700, Synco RXB/RXL, and RDG/RDF/RDU room thermostats, and the QAX Synco living central apartment units.

Use

Building

- Synco living central apartment units in single and multi-family homes.
- Office and administrative buildings, residential housing.
- Schools, gymnasiums, leisure facilities, hotels.
- Municipal buildings, smaller industrial buildings.

Owners/operators

- End customers, HVAC and electrical installers.
- Real estate companies, real estate management companies.
- Building maintenance companies, facility management.

Functions

Primary functions

The OZW772.01... web server primarily serves to:

- Remotely operate and monitor plants and devices on a KNX network using a web browser and/or ACS operator stations.
- Send faults and system reports to e-mail recipients.
- Operate and monitor via customized plant diagrams.

Operation

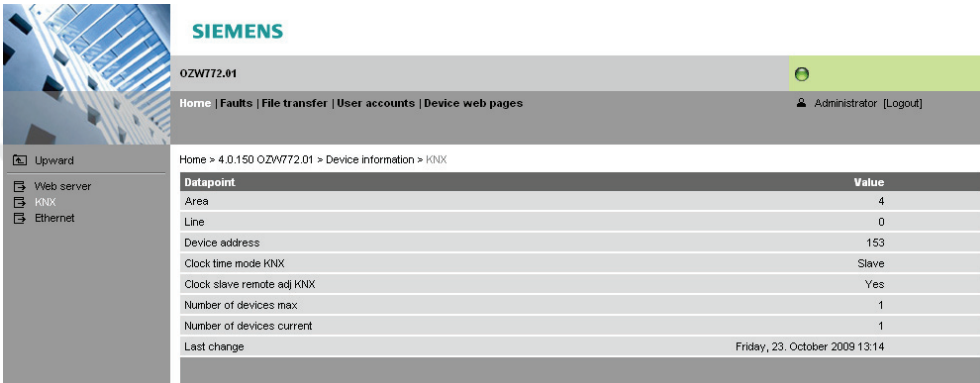

The screenshot shows the Siemens OZW772.01 web interface. The top navigation bar includes 'Home', 'Faults', 'File transfer', 'User accounts', and 'Device web pages'. A user account 'Administrator [Logout]' is visible. The main content area displays a table of datapoints for the selected device.

Datapoint	Value
Area	4
Line	0
Device address	153
Clock time mode KNX	Slave
Clock slave remote adj KNX	Yes
Number of devices max	1
Number of devices current	1
Last change	Friday, 23. October 2009 13:14

Primary navigation

Primary navigation offers the following functions:

Home	Menu-based plant and device operation.
Faults	Display system faults.
File transfer	Show history featuring the last 500 events.
User accounts	User administration.
Device web pages	Create device list and operating pages.

Secondary navigation

The secondary navigation (menu tree) allows users to select devices and operating pages.

Display

The display range displays content corresponding to the selected primary and secondary navigation.

Plant state

The display indicates no fault or the most serious plant fault depending on plant state.

Plant diagrams

The OZW772... web server visualizes via plant diagrams the technical equipment in the building as well as the floor plans with all data points. The user receives a significantly improved overview as plants and room states are displayed from the user's point of view.

In the event of a fault, users can quickly access the impacted locations. For writable parameters, users can click to open a dialog box and change the parameter, as e.g. the "Comfort cooling setpoint" displayed below.

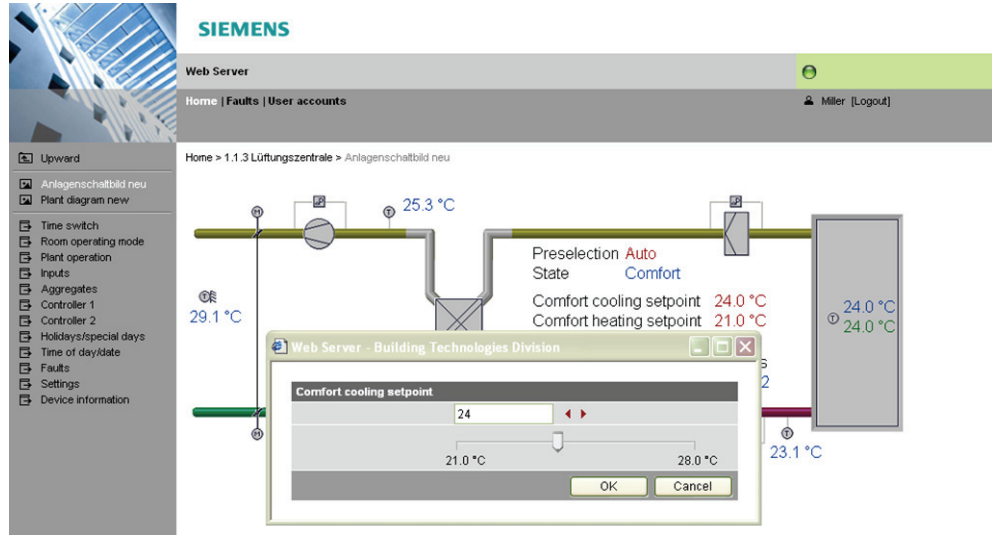



Users can also embed additional data in a plant diagram such as links to plant, function and maintenance descriptions or data sheets. Moreover, users can integrate external links allowing, for example, to directly browse multiple plants. Users can even embed current webcam images in a plant diagram.

Faults

Fault sources

The web server recognizes failures and faults of plants, devices on the KNX network as well as its own faults.

Fault display, fault acknowledgement

The LED  signals a fault on the web server. The LED  blinks to indicate that a fault is unacknowledged. The LED continues to be lit for as long as the fault is pending after the fault is acknowledged with the button via web operation or ACS. (See page 6 for LED displays and operating buttons).

Fault status message

Fault status messages can be sent as an e-mail to as many as 4 e-mail recipients and/or via a service provider to SMS recipients. The fault priority for each e-mail recipient (urgent/all) can be set. Each recipient has a "Time switch with calendar" to program three sending times per day and holidays/special days.

System report

System messages

The web server generates system reports and periodically sends the system state to e-mail recipients. Messages are sent as per the set time (hh:mm), the message cycle interval (1...255 days), and priority (urgent/non-urgent).

Connection test

Press the  button on the web server to send a system report to all e-mail recipients regardless of fault priority.

History

The last 500 fault events, fault messages and system reports are entered in the web server's circular message buffer. The events or history data can be read via web browser.

Time

The web server has a system clock with adjustable time zone and daylight saving/standard time changeover. As clock time master, it can send the set system time (date and time) to KNX devices (clock time slave).

Type summary

Name		Product number
Web server	for 1 KNX device	OZW772.01
Web server	for 4 KNX devices	OZW772.04
Web server	for 16 KNX devices	OZW772.16
Web server	for 64 KNX devices	OZW772.64

Ordering and delivery

When ordering, please specify the name and **product number**. Example:

- Web server **OZW772.16**

Each web server is delivered in a cardboard box. The following is included in the package:

- Installation instructions G5701xx (multilingual).
- Power cable, power supply AC 230 V.
- Ethernet cable.
- USB cable.
- 2 cable ties.

Note

The commissioning instructions C5701 (de/en) are saved to the web server at <http://<IP address>/doc/>

Equipment combinations

KNX devices

The following devices from the Synco product range can be connected to each OZW772... web server via KNX.

Synco 700

Devices		Data sheet no.
Universal controllers	RMU7x0, RMU7x0B	N3144, N3150
Heating controllers	RMH760, RMH760B	N3131, N3133
Boiler sequence controller	RMK770	N3132
Central control unit	RMB795	N3121
Switching and monitoring units	RMS705, RMS705B	N3123, N3124
Bus operator unit	RMZ792	N3113
Room unit	QAW740	N1633
Central communication units	OZW771, OZW775	N3117, N5663

	Devices	Data sheet no.	
Synco RXB/RXL	Room controllers	RXB21.1, RXB22.1	N3873
	Room controllers	RXL21.1, RXL22.1	N3877
	Room controller	RXB24.1	N3874
	Room controller	RXL24.1	N3878
Synco RDG/RDF/RDU	Room thermostat for fan coils	RDG100KN	N3191
	Room thermostat for VAV	RDG400KN	N3192
	Room thermostat for fan coils	RDF301	N3171
	Room thermostat for fan coils and lighting	RDF301.50	N3171
	Room thermostat for VAV	RDU341	N3172
Synco living	Central apartment unit	QAX910	N2707

Web browser	Devices	Requirements
	PC/laptop (1024 x 786)	Internet Explorer V6.0, recommended V7.0 or higher Firefox V3.0 or higher
	iPhone (480x320)	Safari (specific to the given end device)

Number of browsers Any number of browsers can be used simultaneously. The maximum data throughput rate is distributed among the browsers. Operation slows down as the number of users increases accordingly.

Product documentation

	Document type	Document no.
Web server OZW772...	Data sheet	N5701
	Installation instructions (package insert)	G5701
	Commissioning instructions	C5701
	CE declaration of conformity	T5701
	Environmental product declaration	E5701
KNX bus	Data sheet	N3127
	Basic documentation	P3127
ACS7... software	Data sheet	N5640
Service tool OCI700.1	Data sheet	N5655

Design

Basic design The web server consists of a housing lower section containing printed circuit boards with interfaces. The upper housing section covers the printed circuit boards. The upper housing section contains the LED displays and one operating button. The connection terminals and additional display and operating elements are located under the removable cover for the upper housing section. All display and operating elements are labeled.

Display and operating elements

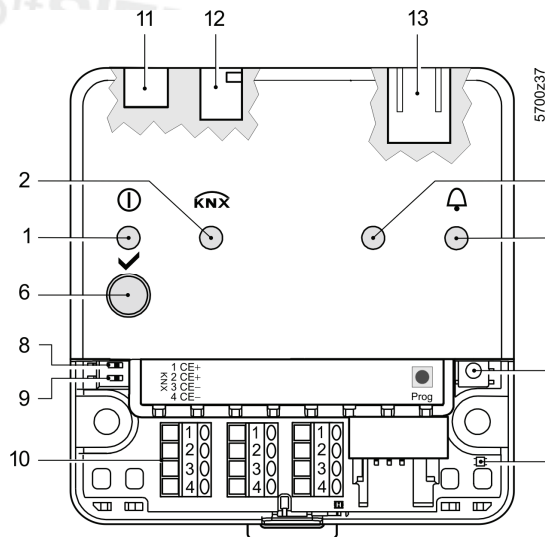

Pos	Name
1	LED On ①
2	LED KNX
3	LED field bus 2 (reserve)
4	LED fault ⚠
5	LED addressing mode
6	Remote button ✓
7	Addressing mode button Prog
8	"Message suppression" switch
9	Switch 2 (no function)
10	KNX bus connection terminals
11	Operating voltage connection
12	USB connection Mini-B
13	Ethernet connection, RJ45 plug

LED displays

1 ① (green/red)	<ul style="list-style-type: none"> • Dark • Steady red • Flashing red • Steady green 	<p>No operating voltage DC 24 V.</p> <p>Web server starts operating system.</p> <p>Web server starts application.</p> <p>Web server operational.</p>
2 KNX (green)	<ul style="list-style-type: none"> • Dark • Lit • Flashing 	<p>No bus power.</p> <p>KNX operational.</p> <p>Communication on KNX.</p>
3 Field bus 2 (reserve)	<ul style="list-style-type: none"> • Dark 	No function.
4 Fault ⚠ (red)	<ul style="list-style-type: none"> • Dark • Lit • Flashing 	<p>No fault (normal operating state).</p> <p>Acknowledged fault.</p> <p>Unacknowledged fault.</p>
5 Addressing mode (red)	<ul style="list-style-type: none"> • Dark • Lit 	<p>KNX addressing mode off.</p> <p>KNX addressing mode on.</p>

Operating buttons

6 Remote button ✓	<ul style="list-style-type: none"> • Short (< 2 s) • Long (> 6 s) 	<p>Acknowledges fault message.</p> <p>Sends system report to all e-mail recipients.</p>
7 Addressing mode Prog	<ul style="list-style-type: none"> • Short (< 2 s) 	<p>Press once: KNX addressing mode on.</p> <p>Press again: KNX addressing mode off.</p>
Button combinations ✓ and Prog	<ul style="list-style-type: none"> • Long (> 6 s) 	<p>Simultaneously pressing the buttons ✓ and Prog restores defaults.</p> <p>i All configuration data and settings are reset. The device list, plant diagrams, and all unsent messages are deleted. History data is not deleted.</p>

Switches

8 Message inhibition	<ul style="list-style-type: none"> • Position ON <input type="checkbox"/> • Position OFF <input type="checkbox"/> 	<p>Sending messages is suppressed (inhibition).</p> <p>Sending messages permitted.</p>
9 DIP switch 2	<ul style="list-style-type: none"> • Switch settings 	No function.

Technical design

Operation, monitoring, alarming

Communication connections for local commissioning (USB) and remote operation, remote monitoring and alarming via Ethernet.

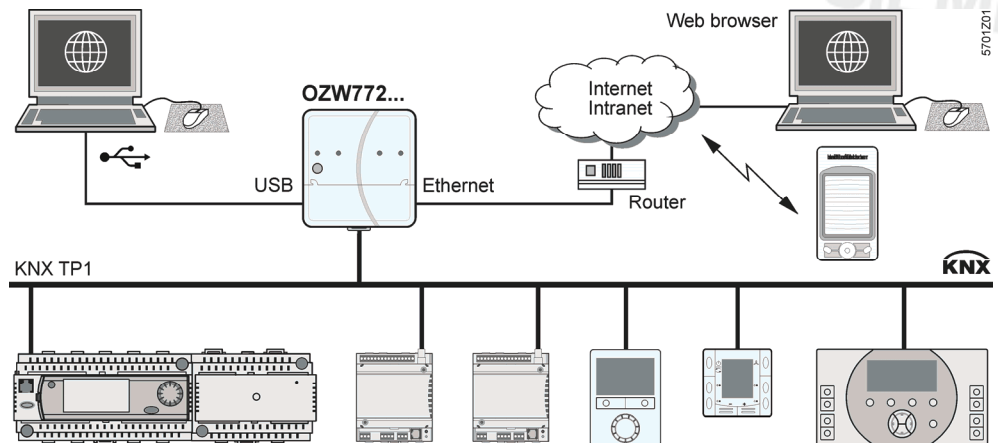

Interfaces

USB

The USB interface directly connects the PC/laptop on site. The required USB cable type A – type Mini-B is delivered with the device.

Ethernet

The router/network is connected to the Ethernet RJ45 plug. The Ethernet interface features Auto-MDI(X) for crossed and non-crossed Ethernet cables. An Ethernet category 5 cable is supplied.

KNX

The KNX bus is connected to the CE+ and CE- connection terminals labeled "KNX". See data sheet N3127 for more information on the KNX bus.

Protocols

Web operation

Use HTTP (Port 80) via TCP/IP for web operation. A RNDIS driver on the PC/laptop is required for USB communication. The RNDIS driver is automatically installed on PC/laptops connected to the Internet (as long as the network administrator enables "online update"). The RNDIS driver is also saved to the web server under <http://<IP address>/drivers/>

Fault messages

Fault messages are sent in an email via SMTP.

Notes

Mounting

The web server can be mounted in a panel, distribution box, or on a wall. Space must be planned for wiring. Make sure the web server is easy to access for servicing and that there is sufficient ventilation.

- Standard mounting On standard rail TH 35-7.5.
- Wall mounting Attached with 2 screws.
- Mounting position Horizontal or vertical.
- Mounting and dimensions See "Dimensions".

Installation

Important notes

Observe the following when installing:

- Run fuses, switches and wiring as per local regulations for electrical installations.
- We do not recommend plant monitoring via USB interface in environments with strong electromagnetic interference (e.g. in industrial environments with electrical welding equipment).
- See "Technical data" for electromagnetic compatibility.

Wiring

Operating voltage

The supplied AC 230 V power supply provides the DC 24 V operating voltage for the web server. The operating voltage plug is located in the upper part of the housing.

USB, Ethernet

The USB and Ethernet plugs are located on the upper part of the housing.

KNX bus

The connection terminals for the KNX bus are located under the removable cover. They are designed for wire diameters of min. 0.5 mm or cross-sections of 0.25...1.5 mm² or stranded wire cross-sections of 0.25...1.0 mm².

Commissioning

Connections

The web server is commissioned locally via USB with a PC/laptop. A web browser or ACS software must be installed on the PC/laptop. The supplied USB cable type A – Type Mini-B connects the web server to the PC/laptop.

Additional information is available in the installation instructions G5701 inserted in the package or the commissioning instructions C5701, available at:
<http://<IP address>/doc/>

Router

A suitable router is required for remote operation via Internet. The router must support NAT/PAT as well as DynDNS for dynamic IP addressing.

IP address

- The IP address via USB is set: **192.168.250.1**.
- Default setting for the IP address via Ethernet: **192.168.251.1**.
- The network administrator must provide an IP address for the web server before you can connect the web server via Ethernet to a managed network.

User groups

User accounts are created and assigned to specific user groups for customized user operation.

End user

Access to end-user data and fault overview. Operate and monitor via menu tree and plant diagrams. Administer own user account.

Service

Same as end user. Additional access to service data and message history as well as updating device web pages.

Administrator

Same as service. In addition, create, copy, edit and delete device web pages and plant diagrams. Administer all user accounts.

Technical data

Power cable for web server OZW772...	Operating voltage	AC 230 V ± 15 %
	Rated voltage	AC 230 V
	Frequency	50/60 Hz
	Power consumption (including web server OZW772...)	3 VA typical
	Protection class	II
	Output voltage	SELV DC 24 V
	Supply line fusing	Max. 16 A
Web server OZW772...	Cable length (distance from AC 230 V plug to web server)	Max. 1.6 m
	Operating voltage	SELV DC 24 V, ± 5 %, 625 mA max.
Function data	Power consumption	2 W typical
	Clock reserve	Min. 72 hours
KNX bus	Device list	
	OZW772.01	1 KNX device
	OZW772.04	up to 4 KNX devices
	OZW772.16	up to 16 KNX devices
	OZW772.64	up to 64 KNX devices
USB	Interface type	TP1 (twisted pair, 1 cable pair)
	2-wire bus	CE+, CE- (non exchangeable)
	Bus load number	E 0.3
	KNX bus power consumption	6 mA
	Permissible line length and cable types	See data sheet N3127
Ethernet	Connection, screw terminals for	
	Solid/stranded wire (twisted or with ferrule)	Min. Ø 0.5 mm
	1 solid wire per terminal	0.25...1.5 mm ²
	1 stranded wire per terminal	0.25...1.0 mm ²
	Interface type	USB V2.0
Industry standards	Device class	RNDIS
	Baud rate	Max. 12 mbps (full speed)
	Connecting cable	
	Cable length	Max. 3 m
	Cable type for connection to PC/laptop	USB type A
Ethernet	Cable type for connection to OZW772...	USB type Mini-B
	Interface type	100BaseTX, IEEE 802.3 compatible
	Bit rate	Max. 100 Mbps
	Protocol	TCP/IP
	Identification	Auto MDI-X
Industry standards	Connection, plug	RJ45 plug (screened)
	Cable type	Standard Cat-5, UTP or STP
	Cable length	Max. 100 m
	Product safety	
	Safety of information technology equipment	EN 60950-1
Industry standards	Home and Building Electronic System (HBES)	EN 50090-2-2
	Electromagnetic compatibility	
	Immunity (Industrial sector)	EN 61000-6-2
	Emissions (Residential, business and commercial as well as light industrial environments)	EN 61000-6-3
	Home and Building Electronic System (HBES)	EN 50090-2-2
Industry standards	CE - Conformity	
	EMC guidelines	2004/108/EC
	Low voltage directive	2006/95/EC
	Ecodesign directive	2005/32/EC
	Conformity	
Australian EMC Framework	AS/NZS 61000-6-3	
Industry standards	Radio Interference Emission Standard	
	Environmental compatibility	
	The product environmental declaration CE1E5701en contains data on environmentally compatible product design and assessments (RoHS compliance, materials composition, packaging, environmental benefit, disposal)	ISO 14001 (environment) ISO 9001 (quality) SN 36350 (environ. compatible products) 2002/95/EC (RoHS)

Degree of protection	Protective category	IP40 ¹⁾ as per EN 60529	
	Protection class	III as per EN 60950-1	
Ambient conditions	Operation	IEC 60721-3-3	
	Climatic conditions	Class 3K5	
	Temperature (housing and electronics)	0...50 °C	
	Humidity	5...95 % r. h. (non-condensing)	
	Mechanical conditions	Class 3M2	
	Transport	IEC 60721-3-2	
Materials and colors	Upper housing section	PC + ASA, RAL 7035 (light-gray)	
	Lower housing section	PC + ASA, RAL 5014 (dove blue)	
	Dimensions	Length x width x height (max. dimensions)	87.5 mm x 90 mm x 40 mm
		Weight	Web server OZW772...
Web server with packaging, installation instructions, power unit, USB and Ethernet cable, cable ties.			0.589 kg
Packaging		Cardboard box	
Terms, abbreviations	Auto Medium Dependent Interface - Crossed	Auto MDI-X	
	Dynamic Domain Name System	DynDNS	
	Hyper Text Transfer Protocol	HTTP	
	Internet Protocol	IP	
	Konnex	KNX	
	Network Address Translation	NAT	
	Port and Address Translation	PAT	
	Remote Network Driver Interface Specification	RNDIS	
	Shielded Twisted Pair	STP	
	Simple Mail Transfer Protocol	SMTP	
	Transmission Control Protocol	TCP	
	Universal Serial Bus	USB	
	Unshielded Twisted Pair	UTP	

General notes

Maintenance	The OZW772... web server is maintenance free (no battery changes, no fuses). Use only a dry towel to clean the housing.
Repair	The OZW772... web server cannot be repaired on site. If faulty, return to the Repair Center at the relevant Regional Company.
Disposal	 <p><i>Dispose of the device as electronic waste in compliance with European directive 2002/96/EEC (WEEE) and not as municipal waste. Observe all relevant national regulations and dispose of the unit correctly. Observe all local and applicable laws.</i></p>

Connection diagrams

Connection diagram

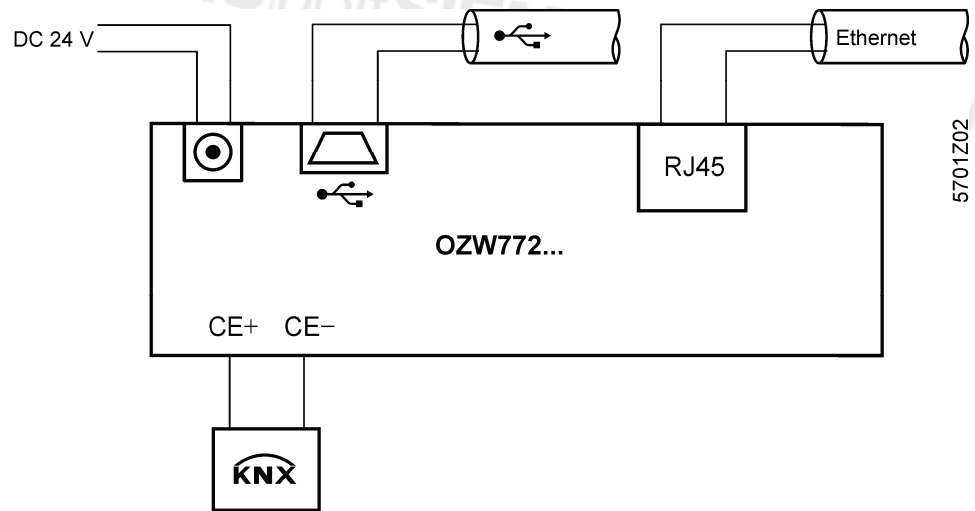

KNX connection terminals

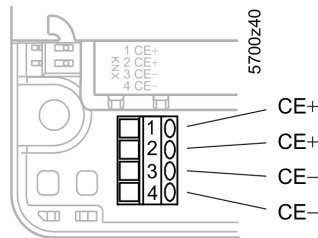

Pin assignment USB

Plug, type Mini-B

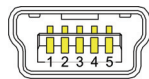

1	VCC	4	ID
2	D -	5	GND
3	D +		

Ethernet

RJ45 plug

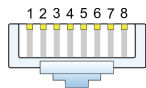

1	Tx+	5	Unused
2	Tx -	6	Rx -
3	Rx +	7	Unused
4	Unused	8	Unused

Power cable

Type Euro plug as per EN 50075 and VDE 0620-1

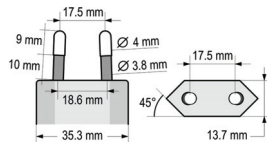

P	AC 230 V	N	AC 230 V
---	----------	---	----------

Operating voltage

DC 24 V plug

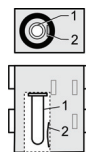

1	DC 24 V (+)	2	GND (-)
---	-------------	---	---------

Dimensions

