



Burner controls

LME75... LME76...

The LME75/LME76 is a microprocessor-based burner control with matching system components for controlling and supervision of forced draft burners of medium to large capacity.

The LME75/LME76 and this data sheet are intended for original equipment manufacturers (OEMs) using the LME75/LME76 in or on their products.

Notes



Caution!

All the safety, warning, and technical notes given in the basic documentation for the LME75/LME76 (P7156) also apply to this document. Failure to observe these poses a risk of damaging the safety functions and the risk of electric shock.

Software version V03.00

CC1N7156en
24.07.2020

Smart Infrastructure

Use

The LME75/LME76 is responsible for commissioning and supervising 1-stage or 2-stage forced draft burners or forced draft burners with pneumatic/mechanical ratio control modulation in continuous operation.

Depending on the LME75/LME76, flame supervision takes place during continuous operation with the following detectors or alarms:

Continuous operation		
LME75	LME76	
•	---	QRA7 UV flame detector
•	---	QRI infrared flame detector
•	•	Ionization probe
---	•	LFS1 flame safeguard with RAR or ionization probe

Intermittent operation		
LME75	LME76	
---	•	LFS1 flame safeguard with QRA2/QRA4/QRA10 UV flame detector
---	•	LFS1 flame safeguard with QRA2/QRA4/QRA10 UV flame detector and ionization probe

- Applications in accordance with EN 267: Forced draft burner for liquid fuels
- Applications in accordance with EN 676: Forced draft burner for gaseous fuels
- Applications in accordance with EN 746-2: Industrial thermoprocessing equipment – Part 2: Safety requirements for combustion and fuel handling systems
- Type-tested and approved in accordance with DIN EN 298

Features

- Undervoltage detection
- Electrical remote lockout reset facility
- Accurate control sequence thanks to digital signal handling
- Multicolor indication of fault status and operational status messages
- Air pressure supervision with function check of air pressure switch during start and operation (depending on PME75/PME76 and the respective parameterization)
- Limitation of restarts
- Parameterizable, controlled intermittent operation after a maximum 24 hours of continuous operation (parameter 239 = 1) e.g., for applications involving an LFS1 flame safeguard and its QRA2/QRA4/QRA10 flame detector
- Continuous operation (parameter 239 = 0)
- BC interface
- The parameters for the LME75/LME76 can be set via the display or the ACS410
- Plug-in space for PME75/PME76

The following items are integrated into the LME75/LME76:

- BC interface for connecting an AZL2 or PC
- Lockout reset button (info button)
- 3-multi color signal lamp (LED) for operating status and fault status messages (lockout reset button (info button) and 3 additional buttons for operation in conjunction with 3 x 7-segment display)
- Analog inputs for load controller DC 0...10 V, DC 0/4...20 mA, 0...135 Ω
- Interface for PME75/PME76
- 3 x 7-segment display for service, fault and status information
- Control for one actuator
- Control for a PWM fan motor (depending on PME75/PME76 and the respective parameterization)

Supplementary documentation

Product type	Designation	Documentation type	Documentation number
PME75.231Ax	Program module	User Documentation	A7156.7
PME75.811Ax	Program module	User Documentation	A7156.1
PME75.812Ax	Program module	User Documentation	A7156.3
PME75.831Ax	Program module	User Documentation	A7156.4
PME76.231Ax	Program module	User Documentation	A7156.8
PME76.811Ax	Program module	User Documentation	A7156.2
PME76.812Ax	Program module	User Documentation	A7156.6
PME76.831Ax	Program module	User Documentation	A7156.5
LME	Burner control	Environmental declaration	E7105 *)
LME	Burner control	Product range overview	Q7101
LME75 / LME76	Burner control	Basic documentation	P7156
PME	Program module	Environmental declaration	E7105.1 *)

*) On request only



Applied directives:

- Low Voltage Directive 2014/35/EU
- Pressure Equipment Directive 2014/68/EU
- Gas Appliances Regulation (EU) 2016/426
- Electromagnetic Compatibility EMC (immunity) * 2014/30/EU

*) The compliance with EMC emission requirements must be checked after the burner control is installed in the equipment

Compliance with the regulations of the applied directives is verified by the adherence to the following standards / regulations:

- Automatic burner control systems for burners and appliances burning gaseous or liquid fuels DIN EN 298
- Safety and control devices for gas burners and gas-burning appliances – Valve proving systems for automatic shutoff valves DIN EN 1643
- Safety and control devices for gas burners and gas-burning appliances – General requirements DIN EN 13611
- Automatic electrical controls for household and similar use Parts 2–5: Particular requirements on automatic electrical burner control and monitoring systems EN 60730-2-5

The edition of the standards that applies in each case can be found in the declaration of conformity.

Note on DIN EN 60335-2-102!

Household and similar electrical appliances – Safety Part 2-102: Particular requirements for gas, oil and solid-fuel burning appliances having electrical connections. The electrical connections of the LME75/LME76 comply with the requirements of EN 60335-2-102.



EAC Conformity (Eurasian Conformity)



ISO 9001:2015
ISO 14001:2015
OHSAS 18001:2007



China RoHS
Hazardous substances table:
<http://www.siemens.com/download?A6V10883536>



120 V AC versions only



SIL3 classification to DIN EN 13611

SIL3

Suitable for use in safety-related, industrial applications up to safety level SIL3 (safety integrity level 3).

The following parameters apply:

Burner control	Flame detector / Flame safeguard	Operating mode	SIL level	PFHD [1/h]	SFF
LME75	Ionization probe	Continuous operation	SIL3	$3.0 \cdot 10^{-8}$	97%
LME75	Ionization probe and QRI	Continuous operation	SIL3	$3.1 \cdot 10^{-8}$	97%
LME75	Ionization probe and QRA7	Continuous operation	SIL3	$4.0 \cdot 10^{-8}$	99%
LME76	Ionization probe	Continuous operation	SIL3	$3.0 \cdot 10^{-8}$	97%
LME76	LFS1.11Ax with RAR9	Continuous operation	SIL3	$4.3 \cdot 10^{-8}$	97%
LME76	LFS1.21Ax with ionization probe	Continuous operation	SIL3	$4.3 \cdot 10^{-8}$	97%

 **Caution!**
 Only permitted in intermittent operation (where continuous operation is <24 hours)
Parameter 239 = 1 and parameter 218 = 80050.31 seconds
 or with external control via heat request of no more than 24 hours.

LME76	LFS1.21Ax with QRA2 / QRA4 / QRA10	Intermittent (<24 hours)	SIL2	$2.5 \cdot 10^{-7}$	99%
LME76	LFS1.21Ax with ionization probe and QRA2 / QRA4 / QRA10	Intermittent (<24 hours)	SIL2	$2.5 \cdot 10^{-7}$	99%

 **Caution!**
 Only permitted with a maximum operating duration in intermittent mode (<1 hour of continuous operation)
Parameter 239 = 1 and parameter 218 = 3589.7 seconds
 or with external control via heat request of no more than 1 hour.

LME76	LFS1.21Ax with QRA2 / QRA4 / QRA10	Maximum operating duration in intermittent mode (<1 hour)	SIL3	$6.3 \cdot 10^{-8}$	99%
-------	------------------------------------	---	------	---------------------	-----

Lifetime

The LME75/LME76 has a designed lifetime* of 250,000 burner startup cycles which, under normal operating conditions in heating mode, corresponds to approx. 10 years of usage (starting from the date of manufacture on the nameplate). This lifetime is based on the endurance tests specified in standard EN 298.

A summary of the conditions has been published by the European Control Manufacturers Association (Afecor) (www.afecor.org).

The designed lifetime is based on use of the LME75/LME76 according to the manufacturer's data sheet and the basic documentation. After reaching the designed lifetime in terms of the number of burner startup cycles, or after the corresponding usage time, the LME75/LME76 must be replaced by authorized personnel.

* The designed lifetime is not the warranty time specified in the Terms of Delivery.

System overview

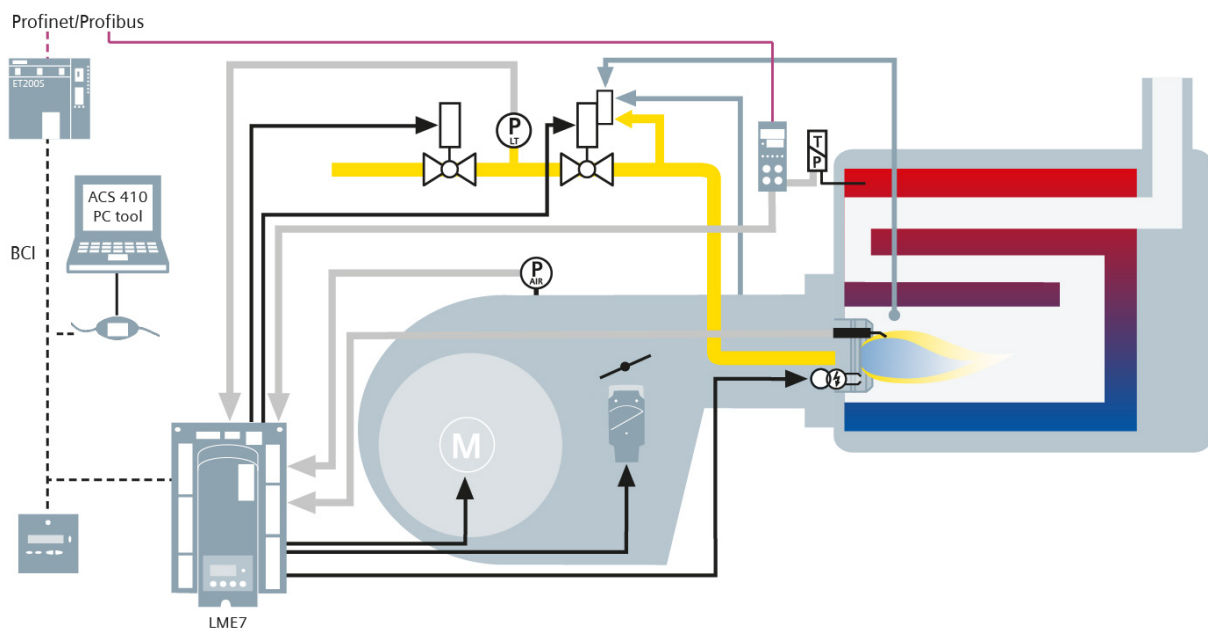

The diagram shows the full scope of functions of the LME75/LME76. The actual functions are to be determined based on the respective execution or configuration.

The system components for the LME75/LME76 (AZL2) are connected directly to the LME75/LME76 via the BC interface. All safety-related digital inputs and outputs of the system are monitored by a contact feedback network. For continuous operation, the ionization probe, QRA7, QRI, or LFS1 flame detector (including its flame detector RAR or ionization probe) can be used in conjunction with the LME75/LME76. The LME75/LME76 is operated and parameterized via the AZL2 or ACS410. The AZL2 features an LCD and menu-driven operation, offering straightforward operation and targeted diagnostics. When making diagnostics, the display shows operating states and the type of error. Passwords protect the different parameter levels of the burner/boiler manufacturer and heating engineer against unauthorized access. Simple settings that the plant operator can make on site do not require a password.

Type summary

Burner control

LME7...

Parameterized LME75/LME76 for the supervision of multistage or modulating forced draft oil/gas burners and atmospheric burners of medium to large capacity in continuous operation. With controlled air damper control. See Basic Documentation P7156.



Article no.	S553333-B201-A100	S553333-B203-A100	S553333-B202-A100	S553333-B204-A100
Type	LME75.000A1	LME76.000A1	LME75.000A2	LME76.000A2
Mains voltage 120 V AC	●	●	---	---
Mains voltage 230 V AC	---	---	●	●
Pressure switch-min / pressure switch-max or POC → Depending on the PME75/PME76 and respective parameterization	●	●	●	●
Pressure switch valve proving → Depending on the PME75/PME76 and respective parameterization	●	●	●	●
Air pressure switch	●	●	●	●
Ionization probe	●	●	●	●
QRA7	●	---	●	---
QRI	●	---	●	---
LFS1	---	●	---	●
Load controller analog input signal (0...10 V, 4...20 mA, 0...135 Ω)	●	●	●	●
Load controller input, 3-position step input or 2-stage	●	●	●	●
Actuator control output	●	●	●	●
Input 0...1 kΩ of the feedback from an actuator with ASZ	●	●	●	●
Output PWM fan motor (on request)	●	●	●	●
Onboard LED 7-segment display	●	●	●	●
BC interface for AZL2 and OCI410 with ACS410	●	●	●	●
Continuous operation (intermittent mode parameterized)	●	●	●	●

Accessories (must be ordered separately)

Program module

PME7...

PME75/PME76 for the LME75/LME76, with oil or gas burner program sequences for the LME75/LME76. Refer to basic documentation for P7156.

Example:



PME75/PME76 with 120 V AC mains voltage

Article no.	S55333-B301-A100	S55333-B303-A100	S55333-B305-A100	S55333-B307-A100	S55333-B309-A100	S55333-B311-A100	S55333-B313-A100	S55333-B315-A100
Type	PME75.231A1	PME75.811A1	PME75.812A1	PME75.831A1	PME76.231A1	PME76.811A1	PME76.812A1	PME76.831A1
Mains voltage 120 V AC	●	●	●	●	●	●	●	●
For use with LME75.000A1	●	●	●	●	---	---	---	---
For use with LME76.000A1	---	---	---	---	●	●	●	●
Forced draft burner gas program	---	●	●	●	---	●	●	●
Atmospheric burner gas program	---	●	●	●	---	●	●	●
Forced draft oil burner	●	---	---	●	●	---	---	●
1-stage or 1-stage modulating	---	●	●	●	---	●	●	●
2-stage or 1-stage modulating	●	●	●	●	●	●	●	●
Simultaneous pilot burners	---	●	●	---	---	●	●	---
Alternating pilot burners	●	●	●	●	●	●	●	●
Modulating via actuator (pneumatic or mechanical fuel-air ratio control)	●	●	●	●	●	●	●	●
Actuator control via analog signal or 3-position step signal for actuator with ASZ → depending on the parameterization	●	●	●	●	●	●	●	●
3-position signal for actuator without ASZ	●	●	●	●	●	●	●	●
Control sequence programmable time	●	●	●	●	●	●	●	●
POC → depending on the parameterization	●	●	●	---	●	●	●	---
Leakage control → depending on the parameterization	---	●	---	●	---	●	---	●
Valve proving input ON/OFF (via external switch) → depending on the parameterization	---	---	---	●	---	---	---	●
Gas pressure switch-max → depending on the parameterization	---	●	●	●	---	●	●	●
Oil pressure switch-min / oil pressure switch-max → depending on the parameterization	●	---	---	---	●	---	---	---
Oil preheater / oil temperature limiter → depending on the parameterization	●	---	---	---	●	---	---	---

Accessories (to be ordered separately) (continued)

Program module

PME7...

PME75/PME76 for the LME75/LME76, with oil or gas burner program sequences for the LME75/LME76. Refer to basic documentation for P7156.

Example:



PME75/PME76 with 230 V AC mains voltage

Article no.	S55333-B302-A100	S55333-B304-A100	S55333-B306-A100	S55333-B308-A100	S55333-B310-A100	S55333-B312-A100	S55333-B314-A100	S55333-B316-A100
Type	PME75.231A2	PME75.811A2	PME75.812A2	PME75.831A2	PME76.231A2	PME76.811A2	PME76.812A2	PME76.831A2
Mains voltage 230 V AC	●	●	●	●	●	●	●	●
For use with LME75.000A2	●	●	●	●	--	--	--	--
For use with LME76.000A2	--	--	--	--	●	●	●	●
Forced draft burner gas program	--	●	●	●	--	●	●	●
Atmospheric burner gas program	--	●	●	●	--	●	●	●
Forced draft oil burner	●	--	--	●	●	--	--	●
1-stage or 1-stage modulating	--	●	●	●	--	●	●	●
2-stage or 1-stage modulating	●	●	●	●	●	●	●	●
Simultaneous pilot burners	--	●	●	--	--	●	●	--
Alternating pilot burners	●	●	●	●	●	●	●	●
Modulating via actuator (pneumatic or mechanical fuel-air ratio control)	●	●	●	●	●	●	●	●
Actuator control via analog signal or 3-position step signal for actuator with ASZ → depending on the parameterization	●	●	●	●	●	●	●	●
3-position signal for actuator without ASZ	●	●	●	●	●	●	●	●
Control sequence programmable time	●	●	●	●	●	●	●	●
POC → depending on the parameterization	●	●	●	--	●	●	●	--
Leakage control → depending on the parameterization	--	●	--	●	--	●	--	●
Valve proving input ON/OFF (via external switch) → depending on the parameterization	--	--	--	●	--	--	--	●
Gas pressure switch-max → depending on the parameterization	--	●	●	●	--	●	●	●
Oil pressure switch-min / oil pressure switch-max → depending on the parameterization	●	--	--	--	●	--	--	--
Oil preheater / oil temperature limiter → depending on the parameterization	●	--	--	--	●	--	--	--

Accessories (to be ordered separately) (continued)

Display units / operating units and accessories

Article no.	Type	
BPZ:AZL21.00A9	AZL21.00A9	<p>Display and operating unit</p> <ul style="list-style-type: none"> • Separate unit for a choice of mounting methods with LCD • 8 digits • 5 buttons • BC interface for LME75/LME76 • Protection type IP40 <p>Refer to data sheet N7542</p>
BPZ:AZL23.00A9	AZL23.00A9	<p>Display and operating unit</p> <ul style="list-style-type: none"> • Separate unit for a choice of mounting methods with LCD • 8 digits • 5 buttons • BC interface for LME75/LME76 • Protection type IP54 <p>Refer to data sheet N7542</p>
---	---	<p>3-color LED</p> <ul style="list-style-type: none"> • Installed in LME75/LME76 • Lockout reset button (info button) • 3 other buttons for operation in connection with 3 x 7-segment display
BPZ:AGV50.100	AGV50.100	<p>Signal cable for AZL2</p> <ul style="list-style-type: none"> • With RJ11 plug • Cable length 1 m • Packs of 10 pieces <p>Every LME75/LME76 must come complete with a cable to connect it to the AZL2.</p>



LFS1 flame safeguard



Note!
Depending on the flame safeguard used.

LME76 only
External flame safeguard with approval for continuous operation for the supervision of oil and gas flames.
Refer to data sheet N7782.

Article no.	Type	Flame detector	Operating mode
BPZ:LFS1.11A1 BPZ:LFS1.11A2	LFS1.11A1 LFS1.11A2	RAR9	Continuous operation
BPZ:LFS1.21A1 BPZ:LFS1.21A2	LFS1.21A1 LFS1.21A2	Ionization probe	Continuous operation
BPZ:LFS1.21A1 BPZ:LFS1.21A2	LFS1.21A1 LFS1.21A2	QRA2/QRA4/QRA10	Intermittent
BPZ:LFS1.21A1 BPZ:LFS1.21A2	LFS1.21A1 LFS1.21A2	Ionization probe + QRA2/QRA4/QRA10	Intermittent



Accessories (to be ordered separately) (continued)

UV flame detector QRA7 UV flame detector for use with Siemens burner controls for the supervision of gas and oil flames. Refer to data sheet N7712.

Article no.	Type	Mains voltage	Detector tube length
BPZ:QRA73.A17	QRA73.A17	120 V AC	125 mm
BPZ:QRA73.A27	QRA73.A27	230 V AC	125 mm
BPZ:QRA75.A17	QRA75.A17	120 V AC	69 mm
BPZ:QRA75.A27	QRA75.A27	230 V AC	69 mm



Infrared flame detector QRI Infrared flame detector for use with Siemens burner controls for the supervision of gas, oil and other flames that emit infrared light. Refer to data sheet N7719.

Article no.	Type	
BPZ:QRI2A2.B180B	QRI2A2.B180B	<ul style="list-style-type: none"> • Frontal illumination • Cable length 180 cm • Stripped
BPZ:QRI2B2.B180B	QRI2B2.B180B	<ul style="list-style-type: none"> • Lateral illumination • Cable length 180 cm • Stripped
BPZ:QRI2B2.B180B1	QRI2B2.B180B1	<ul style="list-style-type: none"> • Lateral illumination • Cable length 180 cm • Stripped • Accessory 424188550 Flange with radius and clamp



Ionization probe

Article no.	Type	
Supplied by customer	Supplied by customer	Ionization probe for use with Siemens burner controls for the supervision of gas flames.



Accessories (to be ordered separately) (continued)

Actuators SQN70/SQN71 Electromotoric actuators for air dampers and control valves for oil and gas burners of small to medium capacity.
Holding torque 0.7 Nm to 2.5 Nm.
Running time from 2.5 s to 30 s.
Refer to data sheet N7804 for other types.

Article no.	Type	
BPZ:SQN70.664A20	SQN70.664A20	<ul style="list-style-type: none">• Diagram no. 6• Shaft no. 0• Running time 30 s• Operating torque 2.5 Nm• Holding torque 1.3 Nm• Without potentiometer• Direction of rotation left• 230 V AC
BPZ:SQN71.664A10	SQN71.664A10	<ul style="list-style-type: none">• Diagram no. 6• Shaft no. 0• Running time 30 s• Operating torque 2.5 Nm• Holding torque 1.3 Nm• Without potentiometer• Direction of rotation right• 120 V AC
BPZ:SQN71.664A20	SQN71.664A20	<ul style="list-style-type: none">• Diagram no. 6• Shaft no. 0• Running time 30 s• Operating torque 2.5 Nm• Holding torque 1.3 Nm• Without potentiometer• Direction of rotation right• 230 V AC



Actuator SQN72 Electromotoric actuators for air dampers and control valves for oil and gas burners of small to medium capacity.
Holding torque 0.7 Nm to 2.5 Nm.
Running time from 4 s to 30 s.
Refer to data sheet N7802 for other types.

Article no.	Type	
BPZ:SQN72.6C4A20	SQN72.6C4A20	<ul style="list-style-type: none">• Diagram C• Shaft no. 0• Running time 30 s• Operating torque 2.5 Nm• Holding torque 1.3 Nm• With potentiometer• Direction of rotation left• 230 V AC



Accessories (to be ordered separately) (continued)

Actuator SQM40

Electromotoric actuators for air dampers and control valves for oil and gas burners of small to medium capacity.

Holding torque 5 Nm to 10 Nm. Running time from 15 s to 30 s.

Refer to data sheet N7817 for other types.

Article no.	Type	
BPZ:SQM40.281A20	SQM40.281A20	<ul style="list-style-type: none"> • Direction of rotation left • Torque 10 Nm • Running time 30 s • Diagram no. 8 • 3-position step modulation • Shaft no. 1 • European version • 230 V AC • Without potentiometer
BPZ:SQM40.285R11	SQM40.285R11	<ul style="list-style-type: none"> • Direction of rotation left • Torque 10 Nm • Running time 30 s • Diagram no. 8 • 3-position step modulation • Shaft no. 5 • US version / Canadian version • 120 V AC • With 90° double potentiometer
BPZ:SQM40.387A20	SQM40.387A20	<ul style="list-style-type: none"> • Direction of rotation left • Torque 18 Nm • Running time 65 s • Diagram no. 8 • 3-position step modulation • Shaft no. 7 • European version • 230 V AC • Without potentiometer



Accessories (to be ordered separately) (continued)

Actuator SQM41

Electromotoric actuators for air dampers and control valves for oil and gas burners of small to medium capacity.

Holding torque 5 Nm to 10 Nm. Running time from 15 s to 30 s.

Refer to data sheet N7817 for other types.

Article no.	Type	
BPZ:SQM41.285R11	SQM41.285R11	<ul style="list-style-type: none"> • Direction of rotation right • Torque 10 Nm • Running time 30 s • Diagram no. 8 • 3-position step modulation • Shaft no. 5 • US version / Canadian version • 120 V AC • With 90° double potentiometer
BPZ:SQM41.367A21	SQM41.367A21	<ul style="list-style-type: none"> • Direction of rotation right • Torque 18 Nm • Running time 65 s • Diagram no. 6 • 3-position step modulation • Shaft no. 7 • European version • 230 V AC • With 90° double potentiometer
BPZ:SQM41.387R11	SQM41.387R11	<ul style="list-style-type: none"> • Direction of rotation right • Torque 18 Nm • Running time 65 s • Diagram no. 8 • 3-position step modulation • Shaft no. 7 • US version / Canadian version • 120 V AC • With 90° double potentiometer



Accessories (to be ordered separately) (continued)

Actuator SQM5

Electromotoric actuators for air dampers and control valves for oil and gas burners of medium to large capacity.
 Holding torque 10 Nm to 40 Nm.
 Running time from 15 s to 60 s.
 By exchanging the 2 motor connecting cables, the actuator's direction of rotation can be changed from counterclockwise to clockwise (factory settings: counterclockwise).
 Refer to data sheet N7815 for other types.

Article no.	Type	
BPZ:SQM50.480A1	SQM50.480A1	<ul style="list-style-type: none"> • Torque / holding torque 15 Nm • Running time 34 s at 90° • Running time 49 s at 130° • 120 V AC
BPZ:SQM50.480A2	SQM50.480A2	<ul style="list-style-type: none"> • Torque / holding torque 15 Nm • Running time 34 s at 90° • Running time 49 s at 130° • 230 V AC
BPZ:SQM50.680A1	SQM50.680A1	<ul style="list-style-type: none"> • Torque / holding torque 15 Nm • Running time 68 s at 90° • Running time 98 s at 130° • 120 V AC
BPZ:SQM53.480A1	SQM53.480A1	<ul style="list-style-type: none"> • Torque / holding torque 25 Nm • Running time 30 s at 90° • Running time 43 s at 130° • 120 V AC
BPZ:SQM53.580A1	SQM53.580A1	<ul style="list-style-type: none"> • Torque / holding torque 25 Nm • Running time 45 s at 90° • Running time 65 s at 130° • 120 V AC
BPZ:SQM54.480A2	SQM54.480A2	<ul style="list-style-type: none"> • Torque / holding torque 25 Nm • Running time 30 s at 90° • Running time 43 s at 130° • 230 V AC
BPZ:SQM54.580A2	SQM54.580A2	<ul style="list-style-type: none"> • Torque / holding torque 25 Nm • Running time 45 s at 90° • Running time 65 s at 130° • 230 V AC
BPZ:SQM56.680A1	SQM56.680A1	<ul style="list-style-type: none"> • Torque / holding torque 40 Nm • Running time 60 s at 90° • Running time 87 s at 130° • 120 V AC
BPZ:SQM56.680A2	SQM56.680A2	<ul style="list-style-type: none"> • Torque / holding torque 40 Nm • Running time 60 s at 90° • Running time 87 s at 130° • 230 V AC



Accessories (to be ordered separately) (continued)

QPL pressure switch

The pressure switch is used to supervise gas or air pressure.
Refer to data sheet N7221.

QPLx5 with automatic reset:

Pressure range	O-ring connection	
	Type	Article no.
0,1...0,3 kPa	QPL15.003B	S55722-S106-A100
0,2...1 kPa	QPL15.010B	S55722-S107-A100
0,5...5 kPa	QPL15.050B	S55722-S108-A100
0,5...15 kPa	QPL15.150B	S55722-S109-A100
10...50 kPa	QPL15.500B	S55722-S110-A100



Pressure range	1/4" connection	
	Type	Article no.
0,1...0,3 kPa	QPL25.003B	S55722-S101-A100
0,2...1 kPa	QPL25.010B	S55722-S102-A100
0,5...5 kPa	QPL25.050B	S55722-S103-A100
0,5...15 kPa	QPL25.150B	S55722-S104-A100
10...50 kPa	QPL25.500B	S55722-S105-A100



Dummy plug for RJ11

Article no.	Type	
---	---	<ul style="list-style-type: none"> For 6-pin modular plug (RJ11) Supplier recommendation: Molex, order number: 085 999 3256

AGG3 connector sets for LME75/LME76

Article no.	Type	
BPZ:AGG3.710	AGG3.710	<ul style="list-style-type: none"> Complete connector set RAST5 and RAST3.5 Single pack See parts list C7105 (74 319 0642 0)
BPZ:AGG3.720	AGG3.720	<ul style="list-style-type: none"> 10 complete standard connector sets RAST5 and RAST3.5 Packing in bags of 10 pieces for each connector type See parts list C7105 (74 319 0642 0)

Example:
Terminal X5-03



Accessories (to be ordered separately) (continued)

AGG9 connector sets for LME75/LME76 The individual connectors are delivered in packages of up to 200 pieces each.

Article no.	Type	
BPZ:AGG9.201	AGG9.201	Terminal X2-09B (RAST5)
BPZ:AGG9.203	AGG9.203	Terminal X3-02 (RAST5)
BPZ:AGG9.209	AGG9.209	Terminal X10-06 (RAST5)
BPZ:AGG9.301	AGG9.301	Terminal X2-01 (RAST5)
BPZ:AGG9.302	AGG9.302	Terminal X2-03 (RAST5)
BPZ:AGG9.304	AGG9.304	Terminal X4-02 (RAST5)
BPZ:AGG9.306	AGG9.306	Terminal X5-01 (RAST5)
BPZ:AGG9.309	AGG9.309	Terminal X6-03 (RAST5)
BPZ:AGG9.310	AGG9.310	Terminal X7-01 (RAST5)
BPZ:AGG9.311	AGG9.311	Terminal X7-02 (RAST5)
BPZ:AGG9.313	AGG9.313	Terminal X9-04 (RAST5)
BPZ:AGG9.401	AGG9.401	Terminal X2-02 (RAST5)
BPZ:AGG9.403	AGG9.403	Terminal X5-03 (RAST5)
BPZ:AGG9.405	AGG9.405	Terminal X7-04 (RAST5)
BPZ:AGG9.501	AGG9.501	Terminal X3-04 (RAST5)
BPZ:AGG9.504	AGG9.504	Terminal X10-05 (RAST5)
BPZ:AGG9.601	AGG9.601	Terminal X2-09A (RAST5)
BPZ:AGG9.822	AGG9.822	Terminal X65, 2-pole (RAST3.5)
BPZ:AGG9.831	AGG9.831	Terminal X66, 3-pole (RAST3.5)
BPZ:AGG9.841	AGG9.841	Terminal X76, 4-pole (RAST3.5)

Example: X5-03



OCI410 service tools

Service tool between burner control and PC. Facilitates viewing, processing, and recording of setting parameters on site using the ACS410.
Refer to data sheet N7616.

Article no.	Type	
BPZ:OCI410.30	OCI410.30	<ul style="list-style-type: none"> • Heating engineer version (standard) • Parameter change possible for the <i>heating engineer</i> password level
BPZ:OCI410.40	OCI410.40	<ul style="list-style-type: none"> • OEM version • Parameter change possible for the <i>OEM personnel and heating engineer</i> password level



PC software ACS410

PC software for parameterization and visualization of the burner control.
On request.
Refer to software documentation J7352.

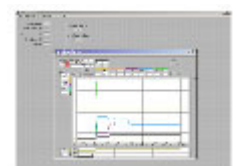

Technical data

Basic unit LME75/LME76

General

Mains voltage	120 V AC	230 V AC
Mains frequency	50/60 Hz	50/60 Hz
External primary fuse	Max. 6.3 A, slow	Max. 6.3 A, slow



Warning!

Risk of damage to the switching contacts!

If the external primary fuse (Si) is blown due to overload or short-circuit at the terminals, the LME75 / LME76 must be replaced.

Power consumption	<10 W, typically	<10 W, typically
Safety class	I with parts according to II and III in accordance with DIN EN 60730-1	
Degree of protection	IP00	



Note

The burner or boiler manufacturer must ensure degree of protection IP40 in accordance with DIN EN 60529 for burner controls through adequate installation of the LME75/LME76.

Rated surge voltage category III (DIN EN 60664)

- LME75 / LME76 4 kV
- Creepage distances and air gaps 2.5 kV due to voltage limitation measures

Pollution degree 2 in accordance with DIN EN 60730-1

Software class Class C in accordance with DIN EN 60730-1:2012 / DIN EN 60730-2-5:2015 2-channel structure

Reaction time in the event of loss of flame Depending on parameter 217.01 (see *Factory settings*)

Permissible mounting position Optional

Weight Approx. 490 g

Technical data (continued)

Terminal loading: *Inputs*

Mains voltage: The input current for the power supply is dependent on the operating status of the LME75/LME76

Undervoltage	UMains 120 V	UMains 230 V
• Safety shutdown from the operating position at mains voltage	≤ 75 V AC	≤ 165 V AC
• Restart is initiated when mains voltage exceeds	≥ 100 V AC	≥ 195 V AC

The remote lockout reset (terminal X2-03 pin 1), control thermostat or limit thermostat (terminal X5-03 pin 1), load controller (terminal X5-03 pin 2/3), POC/CPI (terminal X2-02 pin 4), pressure switch (terminal X5-01 pin 2), air pressure switch (terminal X3-02 pin 1), and actuator (terminal X2-09 pin 4) status inputs are used for system supervision and require mains-related input voltage

- Terminal X3-04 pin 1 / pin 2: Safety loop input Refer to *Terminal loading: Outputs*

- Input currents and input voltages

- UeMax	UN +10%	UN +10%
- UeMin	UN -15%	UN -15%
- IeMax	2.5 mA (peak value)	2.5 mA (peak value)
- IeMin	0.8 mA (peak value)	0.8 mA (peak value)

- Contact material recommended for external signal sources (air pressure switch, pressure switch-min, pressure switch-max, etc.) Gold-plated silver contacts

- Transition behavior / settling behavior / bounce.

- Permitted bounce time of contacts when switching on/off Max. 50 ms (after the bounce time, the contact must stay closed or open)

• UN	120 V AC	230 V AC
• Voltage detection		
- ON	>60 V AC	>120 V AC
- OFF	<40 V AC	<80 V AC

Terminal X65: Analog input	0...10 V DC / DC 0/4...20 mA / 0...135 Ω	
----------------------------	--	--

Technical data (continued)

Terminal output: *Outputs*

Total contact loading:

• Rated voltage	120 V AC, 50/60 Hz	230 V AC, 50/60 Hz
• Terminal X3-04: Input current for LME75/LME76	Max. 5 A	Max. 5 A



Note

The input current for the LME75 / LME76 at terminal X3-04 pin 5 also flows through safety loop terminal X3-04 pin 1 / pin 2.

The power supply in the LME75 / LME76 to the fan motor, ignition transformer, fuel valves, and actuators is interrupted as soon as one of the components opens the safety loop circuit.

Individual contact loading:

Terminal X2-01 pin 3: Fan motor

• Rated voltage	120 V AC, 50/60 Hz	230 V AC, 50/60 Hz
• Rated current	2 A (15 A max. 0.5 s)	2 A (15 A max. 0.5 s)
• Power factor	$\text{Cos}\varphi \geq 0.4$	$\text{Cos}\varphi \geq 0.4$

Terminal X2-02 pin 3: PWM fan motor or oil preheater

(depending on the fuel train; refer to User Documentation A7156.x)

• Rated voltage	120 V AC, 50/60 Hz	230 V AC, 50/60 Hz
• Rated current	2 A	2 A
• Power factor	$\text{Cos}\varphi \geq 0.4$	$\text{Cos}\varphi \geq 0.4$



Caution!

Maximum permissible current load may be exceeded!

If terminal X2-02 pin 3 is used as the connection for supplying the PWM fan motor, no other motor may be connected on terminal X2-01 pin 3.

Terminal X2-03 pin 3: Alarm output

• Rated voltage	120 V AC, 50/60 Hz	230 V AC, 50/60 Hz
• Rated current	1 A	1 A
• Power factor	$\text{Cos}\varphi \geq 0.6$	$\text{Cos}\varphi \geq 0.6$

Terminal X2-09 pin 7: Output relay contact K2/2 (actuator cam ZL, V2a)

• Rated voltage	120 V AC, 50/60 Hz	230 V AC, 50/60 Hz
• Rated current	1 A	1 A
• Power factor	$\text{Cos}\varphi \geq 0.4$	$\text{Cos}\varphi \geq 0.4$

Terminal X3-04 pin 2: Safety loop

• Rated voltage	120 V AC, 50/60 Hz	230 V AC, 50/60 Hz
• Total current	2 A	2 A
• Power factor	$\text{Cos}\varphi \geq 0.4$	$\text{Cos}\varphi \geq 0.4$

Terminal X4-02 pin 3: Ignition transformer

• Rated voltage	120 V AC, 50/60 Hz	230 V AC, 50/60 Hz
• Rated current	2 A	2 A
• Power factor	$\text{Cos}\varphi \geq 0.4$	$\text{Cos}\varphi \geq 0.4$

Technical data (continued)

Terminal X6-03 pin 3: Safety valve

• Rated voltage	120 V AC, 50/60 Hz	230 V AC, 50/60 Hz
• Rated current	1.5 A	1.5 A
• Power factor	$\text{Cos}\varphi \geq 0.6$	$\text{Cos}\varphi \geq 0.6$

Terminal X7-01 pin 3: Fuel valves or pilot valve (depending on the fuel train, see User Manual A7156.x)

• Rated voltage	120 V AC, 50/60 Hz	230 V AC, 50/60 Hz
• Rated current	1 A	1 A
• Power factor	$\text{Cos}\varphi \geq 0.4$	$\text{Cos}\varphi \geq 0.4$

Terminal X7-02 pin 3: Fuel valve (depending on the fuel train, see User Manual A7156.x)

• Rated voltage	120 V AC, 50/60 Hz	230 V AC, 50/60 Hz
• Rated current		
- Valve proving inactive	2 A	2 A
- Valve proving active	1 A	1 A
• Power factor	$\text{Cos}\varphi \geq 0.4$	$\text{Cos}\varphi \geq 0.4$

Terminal X7-04 pin 4: Fuel valve or pilot valve (depending on the fuel train, see User Manual A7156.x)

• Rated voltage	120 V AC, 50/60 Hz	230 V AC, 50/60 Hz
• Rated current		
- Valve proving inactive	2 A	2 A
- Valve proving active	1 A	1 A
• Power factor	$\text{Cos}\varphi \geq 0.4$	$\text{Cos}\varphi \geq 0.4$



Note!

When activating valve proving (e.g., on shutdown), the load on the valve terminals is restricted. If the terminal load is not reduced, the design lifetime is about 100,000 burner start cycles!

Technical data (continued)

Cable lengths	Terminal X2-01: Fan motor	Max. 30 m (100 pF/m), unshielded
	Terminal X2-02: Multi-function input (POC, pressure switch valve proving, oil preheater), see User Manual A7156.x	Max. 30 m (100 pF/m), unshielded
	Terminal X2-03 Pin 1 / 2: Remote lockout reset (laid separately)	Max. 30 m (100 pF/m), unshielded
	Terminal X2-03 Pin 2 / 3: Alarm	Max. 30 m (100 pF/m), unshielded
	Terminal X3-02: Air pressure switch	Max. 30 m (100 pF/m), unshielded
	Terminal X3-04 Pin 1 / 2: Safety loop	Max. 30 m (100 pF/m), unshielded
	Terminal X3-04 Pin 3...5: Mains supply line	Max. 100 m (100 pF/m)
	Terminal X4-02 Pin 1...3: Ignition transformer	Max. 30 m (100 pF/m), unshielded
	Terminal X5-01: Pressure switch-min	Max. 30 m (100 pF/m), unshielded
	Terminal X5-03 Pin 1...4: Load controller	Max. 30 m (100 pF/m), unshielded
	Terminal X6-03 Pin 1...3: Safety valve	Max. 30 m (100 pF/m), unshielded
	Terminal X7-01 Pin 1...3 / X7-02 Pin 1...3 / X7-04 Pin 1...4: Fuel valve	Max. 30 m (100 pF/m), unshielded
	Terminal X7-01 Pin 1...3 / X7-04 Pin 1...4: Pilot valve	Max. 30 m (100 pF/m), unshielded
	Terminal X9-04: Multi-function input (pressure switch), see User Manual A7156.x	Max. 30 m (100 pF/m), unshielded
	Terminal X10-05 / X10-06: Flame detector	Refer to the <i>Flame supervision</i> chapter in the LME75/LME76 basic documentation (P7156)

Terminal X56: BC Interface	For use under the burner hood or in a control panel Max. 1 m (100 pF/m), unshielded
----------------------------	--

Terminal X65: Load controller analog input	Max. 30 m (100 pF/m), use a shielded cable <10 m, unshielded
---	---

Terminal X66: Actuator potentiometer feedback	Max. 30 m (100 pF/m), unshielded
--	----------------------------------

Terminal X76: PWM fan motor	Max. 30 m (100 pF/m), unshielded
-----------------------------	----------------------------------

Specifications as per EN 60730-1

Type of shutdown or interruption for each circuit

Shutdown with micro switch	1-pole
----------------------------	--------

Mode of operation	Type 2 B
-------------------	----------

Technical data (continued)

Actuators	CLOSED / Ignition position / OPEN Terminal X2-09 pin 1, Terminal X2-09 pin 2, Terminal X2-09 pin 3	1 million switching cycles	1 million switching cycles
	• Rated voltage	120 V AC, 50/60 Hz	230 V AC, 50/60 Hz
	• Rated current	0.1 A	0.1 A
	• Power factor	$\text{Cos}\varphi \geq 0.6$	$\text{Cos}\varphi \geq 0.6$
	Output K2/2 terminal X2-09 pin 7	120 V AC, 50/60 Hz	230 V AC, 50/60 Hz
	• Rated current	Max. 1 A	Max. 1 A
	• Power factor	$\text{Cos}\varphi > 0.4$	$\text{Cos}\varphi > 0.4$
Feedback via input terminal X2-09 pin 8 on the LME75/LME76 depending on the current load of the actuator switching contact used (e.g., cam V2 / V2a).			

Cross-sectional areas

The cross-sectional areas of the mains power lines (L, N, PE) and, if required, the safety loop (safety limit thermostat, water shortage, etc.) must be sized for rated currents according to the selected external primary fuse.
The cross-sectional areas of the other cables must be sized in accordance with the primary fuse for the LME75/LME76 (max. 6.3 AT).



Warning!

Risk of damage to the switching contacts!

If the external primary fuse (Si) is blown due to overload or short-circuit at the terminals, the LME75 / LME76 must be replaced.

Minimum cross-sectional area	0.75 mm ² (single-core or multi-core in accordance with VDE 0100)
------------------------------	---

Cable insulation must be suitable for the respective temperatures and environmental conditions.

RAST5 connector

Mechanical data

Insertion force / contact	≤4 N
Withdrawal force / contact	≥1 N
Tightening torque / screw	0.5 Nm in accordance with DIN EN 60335-1
Contacting with flat pin connector	6.3 x 0.8 mm in accordance with DIN EN 46244 Male multipoint connector in accordance with RAST5 standard
Connection cross sections, conductor screw connection	
• Stranded conductor	Cross section max. 2.5 mm ²
• Stranded conductor with ferrule	Cross section max. 2.5 mm ²
• Stripping length	Approx. 8 mm

Technical data (continued)

RAST3.5 connector

Mechanical data

Connection cross sections, conductor screw connection

- Stranded conductor, fine-wired (flexible) Cross section
Min. 0.14 mm²
Max. 1.5 mm²
- Stranded conductor, fine-wired (flexible) Cross section
with ferrule Min. 0.25 mm²
Max. 1 mm²
- Stripping length Approx. 7 mm
- Screw tightening torque 0.25 Nm

Signal cable AGV50

AZL2/OC1410 → BC interface

Signal cable

Color white
Unshielded
Conductor 4 x 0.141 mm²
With RJ11 connector

Cable length AGV50.100

1 m

Place of installation

Under the burner hood (arrangements for SKII EN 60730-1 also required)

Dummy plug for RJ11

Dummy plug

For 6 pin modular plug (RJ11)

Supplier

Recommendation: Molex
Order number: 085 999 3256

Environmental conditions

Storage

EN 60721-3-1:1997

Climatic conditions

Class 1K3

Mechanical conditions

Class 1M2

Temperature range

-40...+70°C

Humidity

<95% r.h.

Transport

EN 60721-3-2:1997

Climatic conditions

Class 2K3

Mechanical conditions

Class 2M2

Temperature range

-40...+70°C

Humidity

<95% r.h.

Operation

EN 60721-3-3:1994

Climatic conditions

Class 3K3

Mechanical conditions

Class 3M2

Temperature range

-40...+60°C

Humidity

<95% r.h.

Installation altitude

Max. 2,000 m above sea level



Warning!

Condensation, formation of ice, and ingress of water are not permitted. Failure to observe this poses a risk of damaging the safety functions and the risk of electric shock.

Technical data (continued)

Flame supervision with ionization probe

With LME75/LME76 at terminal X10-06.



Warning!

- Provide protection to prevent people from coming into contact with the ionization probe (risk of electric shock)!
- When monitoring ionization currents in earth-free mains, connect terminal X10-06/1 pin 1 to burner ground

Short circuit current	Max. AC 1 mA
Permissible length of flame detector cable (laid separately)	30 m (100 pF/m), unshielded

	At mains voltage	Flame intensity parameter 954.00
	120 V AC / 230 V AC	
Detector voltage between ionization probe and ground (AC voltmeter $R_i \geq 10 \text{ M}\Omega$)	Approx. 300 V AC	
Switching threshold (limit values):		
Switching on (flame ON) (DC ammeter $R_i \leq 5 \text{ k}\Omega$)	1.5 μA	20%
Switching off (flame OFF) (DC ammeter $R_i \leq 5 \text{ k}\Omega$)	0.5 μA	0%
Recommended detector current for reliable operation	4 μA	>40%
Switching threshold in the event of poor flame during operation (LED flashes green)	2 μA	Approx. 30%
Possible detector current with flame (typical)	30 μA	100%

Note!



As the detector line capacitance (detector line length) increases, the voltage at the ionization probe – and thus the detector current – will drop. Long line lengths and very high-ohmic flames may necessitate the use of a low-capacitance detector cable (e.g., ignition cable). In spite of special electronic circuits designed to compensate possible adverse effects of the ignition spark on the ionization current, it is important to ensure that the minimum detector current required is already available during the ignition phase. If this is not the case, the primary ignition transformer connections must be interchanged and/or the electrodes relocated.

Technical data (continued)

Connection diagram

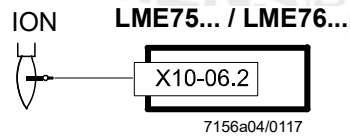

Assignment of terminals for LME75/LME76:
Terminal X10-06 pin 2
Flame signal ionization input

Measuring circuit for detector
current measurement

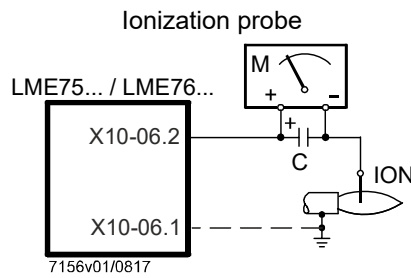

Key

- C Electrolytic condenser 100...470 μF ; 10...25 V DC
- ION Ionization probe
- M Micro-ammeter R_i max. 5000 Ω



Warning!

If the ionization probe and QRA7, QRI, or LFS1 are operated simultaneously, the parameter settings in the following chapters must be observed: "Ionization probe terminal X10-06", "QRA7/QRI terminal X10-05 (LME75 only)", and "LFS1 terminal X10-05 (LME76 only)" in the basic documentation for the LME75/LME76 (P7156).

If this is not observed, there is a risk of device functions being impaired.

Technical data (continued)

Flame supervision with QRA7

With LME75 at terminal X10-05.



Warning!

The QRA7 must not be connected to the LME76. Failure to observe this instruction will result in the LME76 or QRA7 becoming defective.

Supply voltage (terminal X10-05 pin 4 / terminal X10-05 pin 5)

- | | |
|-------------|-----------------------|
| • QRA73.A17 | 120 V AC / 50...60 Hz |
| • QRA73.A27 | 230 V AC / 50...60 Hz |
| • QRA75.A17 | 120 V AC / 50...60 Hz |
| • QRA75.A27 | 230 V AC / 50...60 Hz |

Shutter signal for detector test QRA7 in operation (terminal X10-05 pin 2)

- | | |
|-----------------|---------|
| • Operation | 14 V DC |
| • Detector test | 21 V DC |

Required flame signal voltage (terminal X10-05 pin 1) Min. 3.5 V DC

Threshold values when flame is supervised by QRA7

- | | |
|---------------------------------------|--|
| • Start prevention (extraneous light) | Flame intensity > 5% (parameter 954.01) |
| • Operation | Flame intensity > 50% (parameter 954.01) |

Permissible length of detector cable (laid separately) Max. 100 m

- | | |
|--------------------------------|--|
| • 6-core cable | >4 m (signal line and supply line laid separately) |
| • Supply line no. 1, 2, and PE | Max. 100 m (separate from signal line) |
| • Signal lines no. 3, 4, and 5 | Max. 100 m (shielded) |

Parameter	Function
954.01	Intensity of flame

For more detailed information about QRA7, refer to data sheet N7712.

Connection diagram

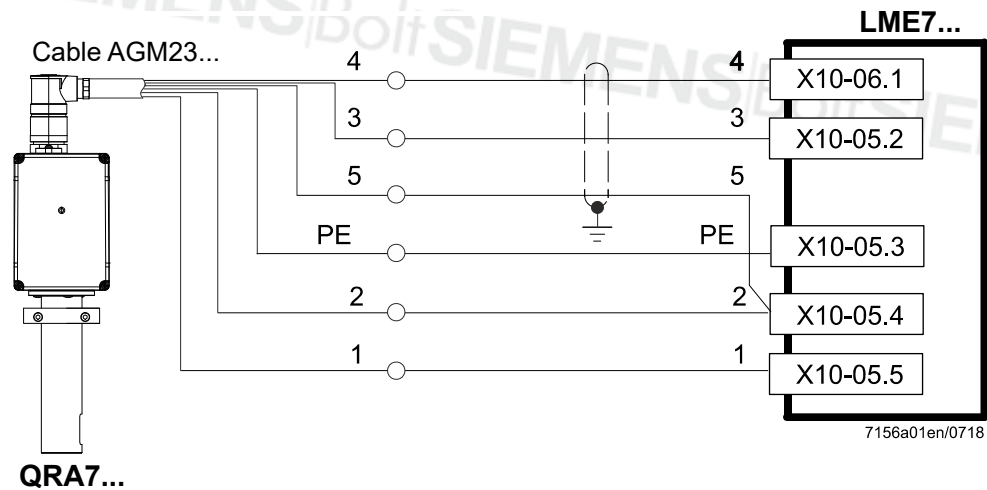

Connection diagram with flame signal measurement

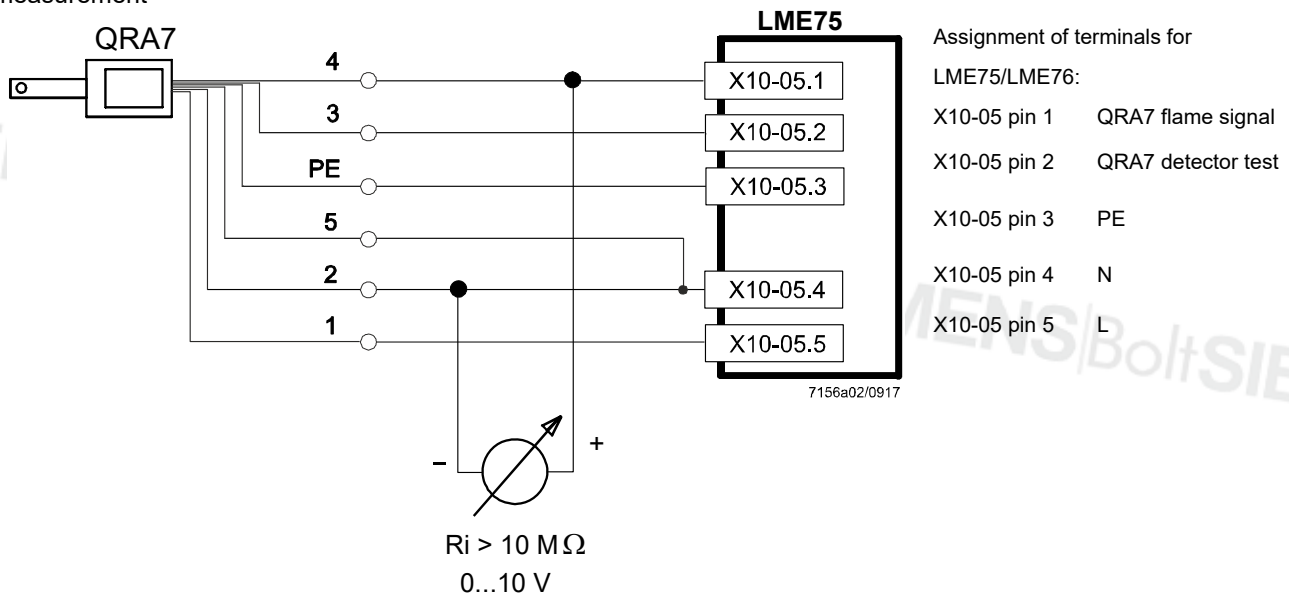

Warning!



- The output terminal X10-05 pin 2 *QRA7 detector test* is not short-circuit-proof! A short-circuit in terminal X10-05 pin 2 to ground can destroy the QRA7 output
- If the ionization probe and QRA7, QRI, or LFS1 are operated simultaneously, the parameter settings in the following chapters must be observed: “Ionization probe terminal X10-06”, “QRA7/QRI terminal X10-05 (LME75 only)”, and “LFS1 terminal X10-05 (LME76 only)” in the basic documentation for the LME75/LME76 (P7156). If this is not observed, there is a risk of device functions being impaired.

Technical data (continued)

Flame supervision with QRI

With LME75 at terminal X10-05.



Warning!
The QRI must not be connected to the LME76. Failure to observe this instruction will result in the LME76 or QRI becoming defective.



Caution!
All measured voltages refer to connection terminal N (terminal X10-05 pin 4).

QRI detector test in operation (terminal X10-05 pin 2)

- Operation 14 V DC
- Detector test 21 V DC

Required flame signal voltage (terminal X10-05 pin 1) Min. 3.5 V DC

Threshold values when flame is supervised by QRI

- Start prevention (extraneous light) Flame intensity > 5% (parameter 954.01)
- Operation Flame intensity > 50% (parameter 954.01)

Permissible length of detector cable (laid separately) Max. 100 m, unshielded
Min. 3 cm distance to other cables

Parameter	Function
954.01	Intensity of flame

For more detailed information about QRI, refer to data sheet N7719.

Connection diagram

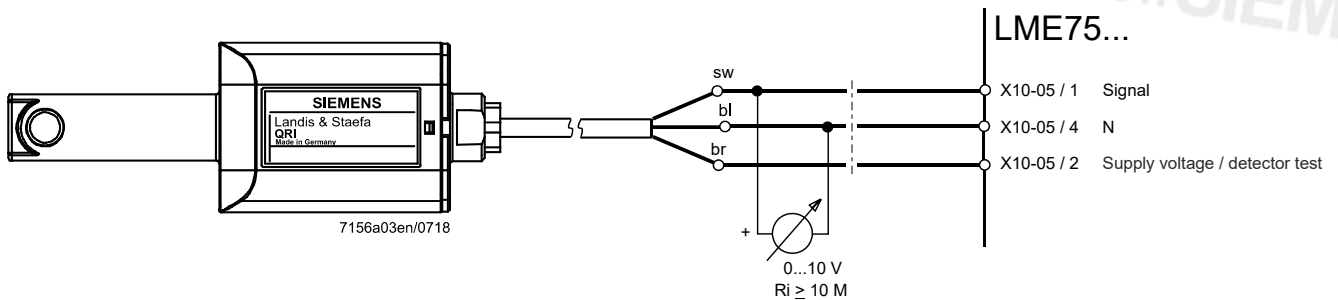

Caution!
Ensure the 3 QRI connecting wires are connected properly. If connected incorrectly to terminal X10-05, there is a risk that the LME75 and QRI may malfunction.

Flame supervision with LFS1

With LME76 at terminal X10-05.



Warning!

An LFS1 or the connection between terminal X10-05 pin 5 and terminal X10-05 pin 1 must not be connected to the LME75. Failure to observe this instruction will result in the LME75 becoming defective.



Caution!

Continuous operation of the LME76 with LFS1 is only permitted in conjunction with...

- LFS1.11Ax and RAR9
- LFS1.21Ax and ionization probe

It is only permitted to operate the LME76 with the LFS1.21Ax and QRA2/QRA4/QRA10 intermittently (with a maximum continuous operation of 24 hours).

Parameter 239 = 1 and parameter 218 = 80050.31 seconds or with external control via heat request < 24 hours.

		Intensity of flame
Required flame signal during operation	Mains voltage at terminal X10-05 pin 3 and no mains voltage at terminal X10-05 pin 1	100%
No flame signal during operation	Mains voltage at terminal X10-05 pin 1 or no mains voltage at terminal X10-05 pin 3	0%
Extraneous light in standby / startup	Mains voltage at terminal X10-05 pin 3 or no mains voltage at terminal X10-05 pin 1	100%
No extraneous light in standby / startup	Mains voltage at terminal X10-05 pin 1 and no mains voltage at terminal X10-05 pin 3	0%

Parameter	Function
954.01	Intensity of flame

For more detailed information on LFS1, refer to data sheet N7782 and user documentation A7782.

Connection diagram of an ionization probe only without LFS1

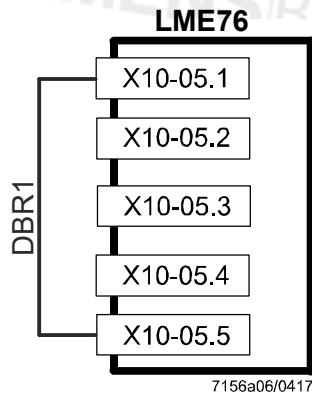

Connection diagram with LFS1

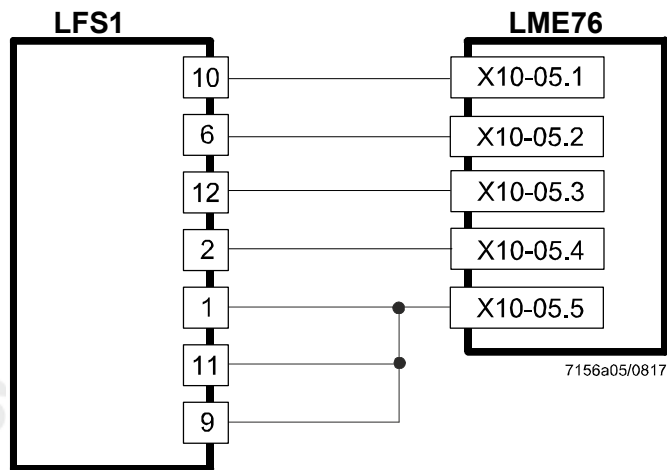

Caution!

Refer to the documentation for the LFS1

→ Data sheet N7782

→ User documentation A7782



Caution!

Refer to the documentation for the PME76

→ User documentation A7156.xx

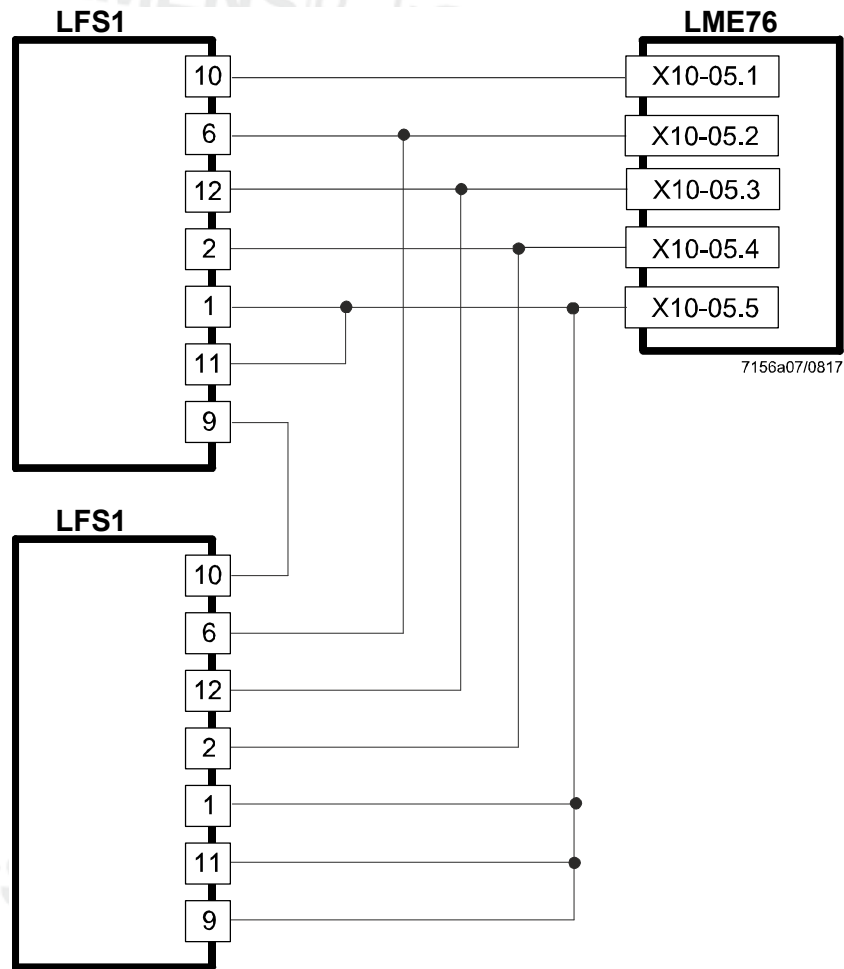

Caution!
Refer to the documentation for the PME76
→ User documentation A7156.xx

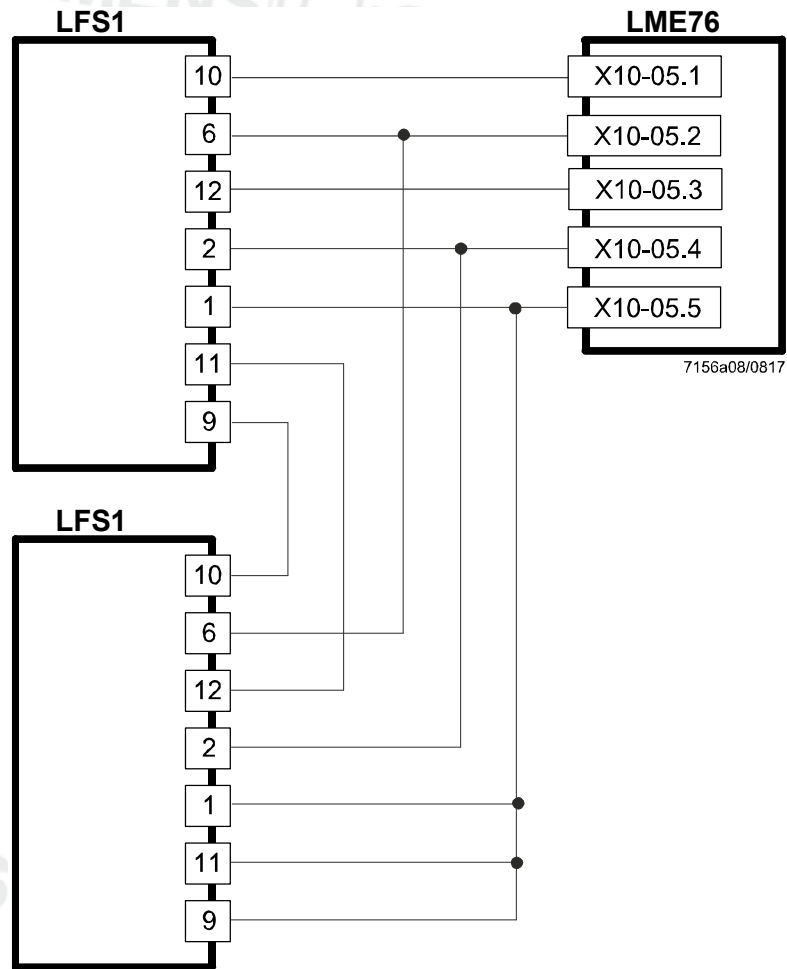

Caution!
Refer to the documentation for the PME76
→ User documentation A7156.xx



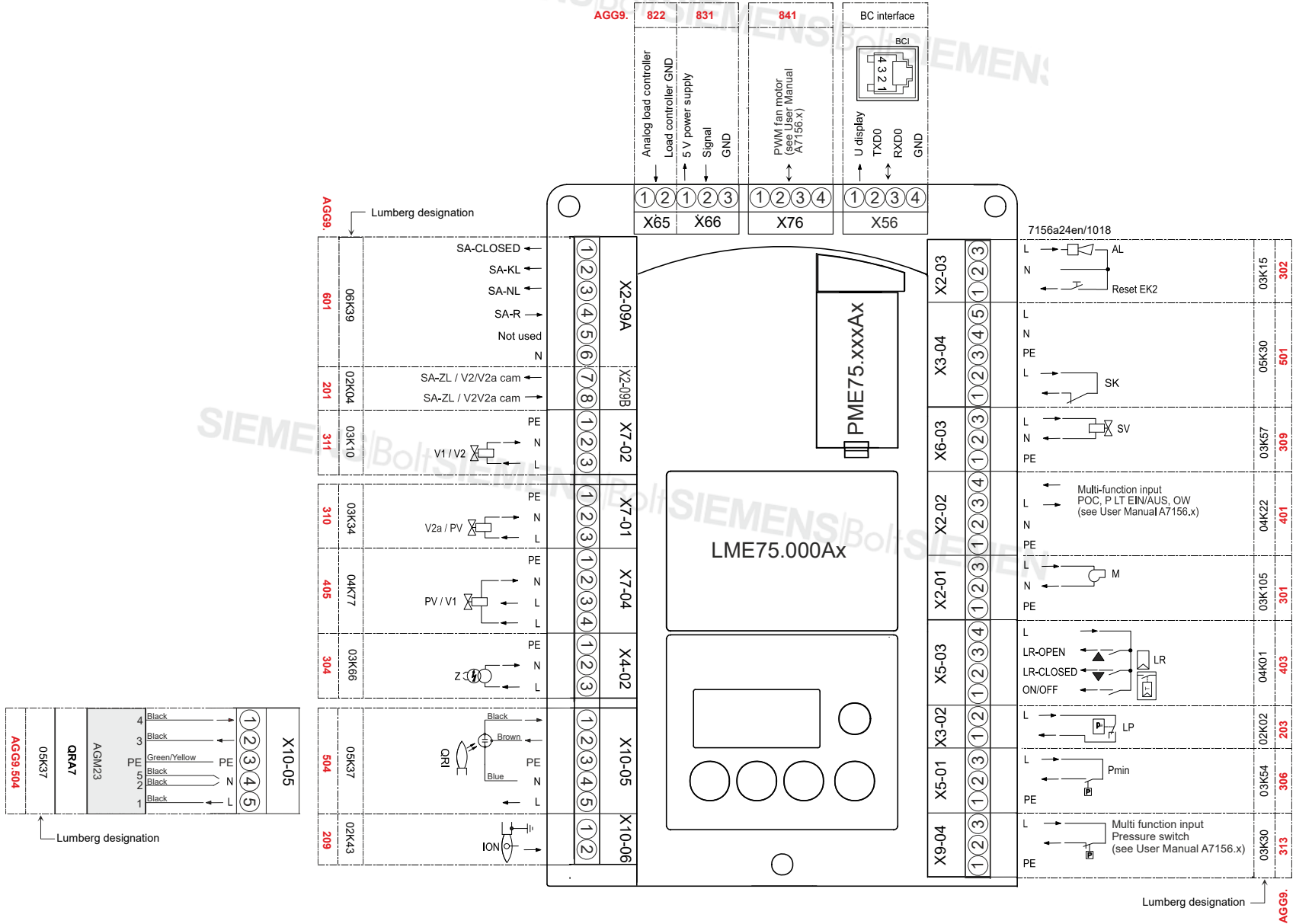

Assignment of terminals for plug AGG9 → LME75

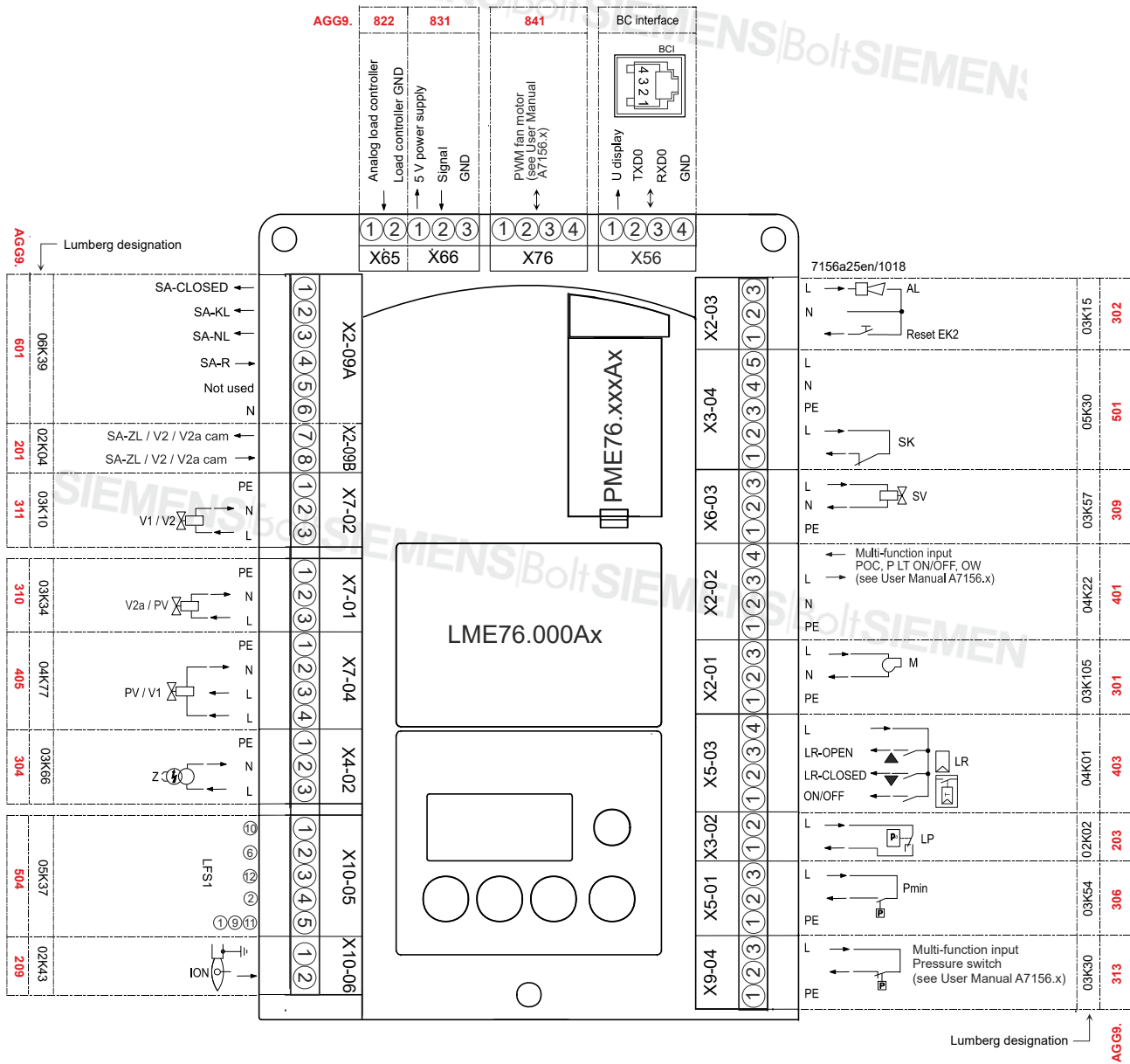

Assignment of terminals for plug AGG9 → LME76



Key

AL	Alarm device
Dbr...	Wire link
	Lockout reset button (info button)
 reset (EK1)	
EK2	Remote lockout reset button
FSV	Flame signal amplifier
ION	Ionization probe
Kx	Relay contact
LED	3-color signal lamp
LFS1	Flame safeguard
LP	Air pressure switch
LR	Load controller
LR-OPEN	Load controller OPEN position
LR-CLOSED	Load controller CLOSED position
M	Fan motor
NT	Power supply unit
P LT	Pressure switch valve proving
Pmax	Pressure switch-max
Pmin	Pressure switch-min
POC	Valve closing control (proof of closure)
PV	Pilot valve
QRA7	UV flame detector
QRI	Infrared flame detector
R	Control thermostat or pressurestat
SA	Actuator
SA-KL	Actuator low-fire
SA-NL	Actuator high-fire
SA-R	Actuator feedback
SA-CLOSED	Actuator CLOSED
SA-ZL	Actuator ignition load
SK	Safety loop
SV	Safety valve
V1	Fuel valve
V2 / V2a	Fuel valve
Z	Ignition transformer
	Input/output signal 1 (ON)
	Input/output signal 0 (OFF)
	Permissible signal 1 (ON) or 0 (OFF)

Dimensions

Dimensions in mm

LME75/LME76

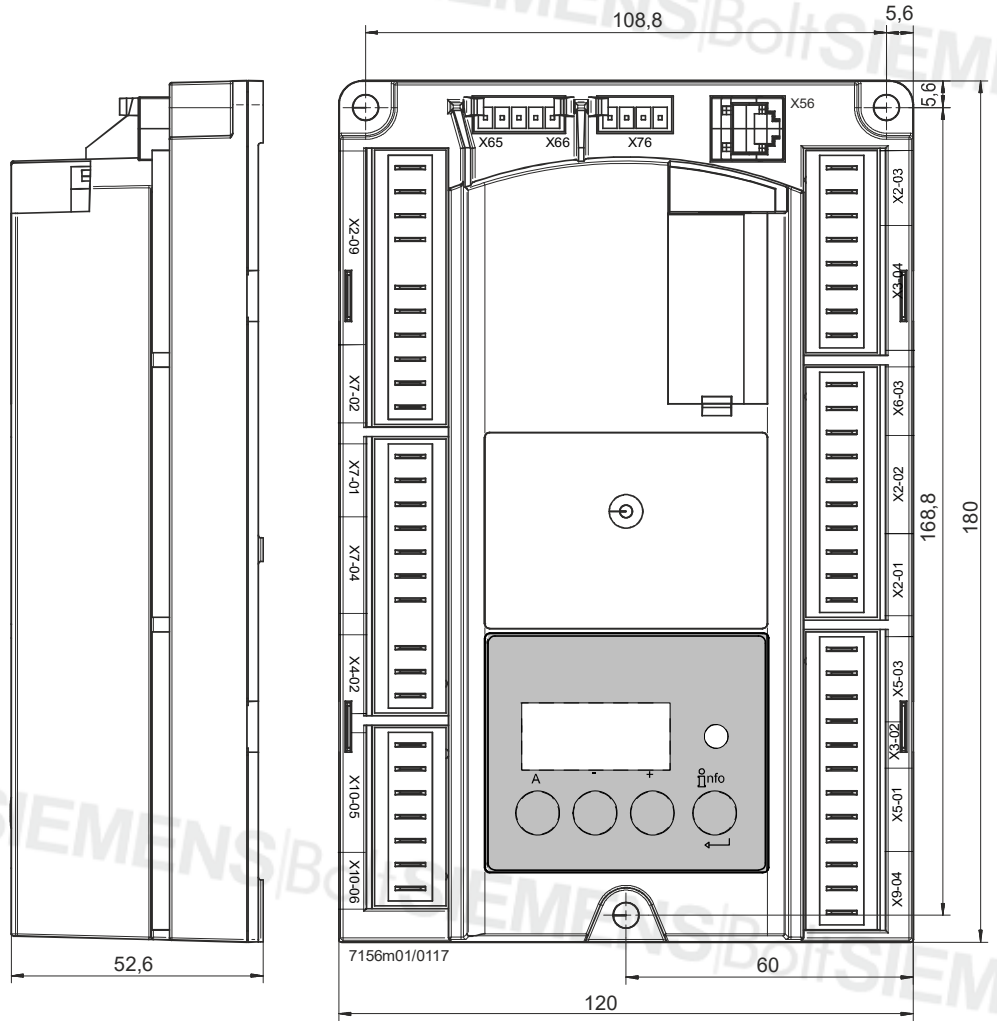

©2020 Siemens AG Smart Infrastructure, Berliner Ring 23, 76437 Rastatt, Germany
Subject to change!