

SIEMENS



Room thermostat with KNX communications RDG400KN

Basic Documentation

Edition: 1.0

CE1P3192en
20 Jul 2010

Building Technologies

Contents

1.	About this document	4
1.1	Revision history	4
1.2	Reference documents	4
1.3	Before you start	5
1.3.1	Copyright	5
1.3.2	Quality assurance	5
1.3.3	Document use / request to the reader	5
1.4	Target audience, prerequisites	6
1.5	Glossary	6
2.	Summary	7
2.1	Types	7
2.2	Ordering	7
2.3	Functions	7
2.4	Integration via KNX bus	9
2.5	Equipment combinations	11
2.6	Accessories	12
3.	Functions	13
3.1	Temperature control	13
3.2	Operating modes	14
3.2.1	Different ways to influence the operating mode	15
3.2.2	Communication examples	19
3.3	Room temperature setpoints	21
3.3.1	Description	21
3.3.2	Setting and adjusting setpoints	22
3.4	Applications overview	24
3.5	Additional functions	25
3.6	Control sequences	28
3.6.1	Sequences overview (setting via parameter P01)	28
3.6.2	Application mode	29
3.6.3	Minimum and maximum air volume	31
3.6.4	Single-duct	32
3.6.5	Single-duct with electric heater	33
3.6.6	Single duct with radiator or floor heating	35
3.6.7	Single-duct with heating / cooling coil	37
3.6.8	Setpoints and sequences	39
3.7	Control outputs	40
3.7.1	Overview	40
3.7.2	Control output for air flow	40
3.7.3	Control output for electrical heater, radiator and heating / cooling coil	41
3.7.4	Control outputs configuration (setting via DIP switches 4/5 or tool, and parameters P46/P47)	43
3.8	Multifunctional input, digital input	44
3.9	Handling faults	46
3.10	KNX communications	46
3.10.1	S-mode	46
3.10.2	LTE mode	46

3.10.3	Zone addressing in LTE mode (in conjunction with Synco)	47
3.10.4	Example of heating and cooling demand zone	49
3.10.5	Send heartbeat and receive timeout	50
3.10.6	Startup	50
3.10.7	Heating and cooling demand	50
3.10.8	Air demand	50
3.10.9	Electric heater interlock by supply air controller (LTE mode only)	51
3.10.10	Primary fan overrun after switching off the electric heater	51
3.10.11	Fault function on KNX	52
3.10.12	Emergency control (LTE Mode only)	53
3.11	Communication objects (S-mode)	54
3.11.1	Overview	54
3.11.2	Description of communication objects	55
3.12	Control parameters	57
3.12.1	Parameter setting via local HMI	57
3.12.2	Parameter setting / download via tool	58
3.12.3	Parameters of the "Service level"	59
3.12.4	Parameters of the "Expert level with diagnostics and test"	60
4.	Handling	62
4.1	Mounting and installation	62
4.2	Commissioning	62
4.3	Operation	65
4.4	Remote operation	67
4.5	Disposal	67
5.	Supported KNX tools	68
5.1	ETS3 Professional	68
5.1.1	Parameter settings in ETS Professional	68
5.2	ACS700 Service and Operating tool	68
5.2.1	Parameter settings in ACS	69
5.2.2	Operation and monitoring with ACS	70
5.2.3	Operation and monitoring with OZW772	72
5.2.4	Operation and monitoring with RMZ972	72
6.	Connection	73
6.1	Connection terminals	73
6.2	Connection diagrams	73
7.	Mechanical design	74
7.1	General	74
7.2	Dimensions	74
8.	Technical data	75
Index	77

1. About this document

1.1 Revision history

Edition	Date	Changes	Section	Pages
1.0	16 Jul 2010	First edition	all	

1.2 Reference documents

Subject	Ref	Doc No.	Description
Room thermostats with KNX communications, RDG400KN	[1]	CE1N3192	Data Sheet
	[2]	CE1B3192	Operating Instructions
	[3]	CE1M3192	Mounting Instructions
KNX Manual	[4]		Handbook for Home and Building Control – Basic Principles (www.knx.org/uk/news-press/publications/publications/)
Synco and KNX (see www.siemens.com/synco)	[5]	CE1N3127	KNX bus, Data Sheet
	[6]	CE1P3127	Communication via the KNX bus for Synco 700, 900 and RXB/RXL, Basic Documentation
	[7]		XLS template Planning and commissioning protocol, in HIT communication Synco 700
	[8]	CE1N3121	RMB395 central control unit, Data Sheet
	[9]	CE1Y3110	KNX S-mode data points
	[10]	--	Product data for ETS3
	[11]	CE1J3110	ETS product data compatibility list
DESIGO engineering documents	[12]	0-92168en	Synco Application Manual
	[13]	CM1Y9775	DESIGO RXB integration – S-mode
	[14]	CM1Y9776	DESIGO RXB / RXL integration – Individual Addressing
	[15]	CM1Y9777	Third-party integration
	[16]	CM1Y9778	Synco integration
	[17]	CM1Y9779	Working with ETS

1.3 Before you start

1.3.1 Copyright

This document may be duplicated and distributed only with the express permission of Siemens, and may be passed only to authorized persons or companies with the required technical knowledge.

1.3.2 Quality assurance

This document was prepared with great care.

- The contents of this document is checked at regular intervals
- Any corrections necessary are included in subsequent versions
- Documents are automatically amended as a consequence of modifications and corrections to the products described

Please make sure that you are aware of the latest document revision date.

If you find lack of clarity while using this document, or if you have any criticisms or suggestions, please contact the Product Manager in your nearest branch office.

The addresses of the Siemens Regional Companies are available at

www.buildingtechnologies.siemens.com.

1.3.3 Document use / request to the reader

Before using our products, it is important that you read the documents supplied with or ordered at the same time as the products (equipment, applications, tools, etc.) carefully and in full.

We assume that persons using our products and documents are authorized and trained appropriately and have the technical knowledge required to use our products as intended.

More information on the products and applications is available:

- On the intranet (Siemens employees only) at <https://workspace.sbt.siemens.com/content/00001123/default.aspx>
- From the Siemens branch office near you www.buildingtechnologies.siemens.com or from your system supplier
- From the support team at headquarters fieldsupport-zug.ch.sbt@siemens.com if there is no local point of contact

Siemens assumes no liability to the extent allowed under the law for any losses resulting from a failure to comply with the aforementioned points or for the improper compliance of the same.

1.4 Target audience, prerequisites

This document assumes that users of the RDG KNX thermostats are familiar with the ETS3 Professional and/or Synco ACS700 tools and able to use them.

It also presupposes that these users are aware of the specific conditions associated with KNX.

In most countries, specific KNX know-how is conveyed through training centers certified by the KNX Association (see www.konnex.org/).

For reference documentation, see section 1.2.

1.5 Glossary

The inputs, outputs and parameters of an application can be influenced in various ways. These are identified by the following symbols in this document:



ETS3 Professional

Parameters identified by this symbol are set using ETS3 Professional.



ACS Service

Parameters identified by this symbol are set using the ACS Service tool.



ACS Operating

Parameters identified by this symbol can be monitored using the ACS Operating tool.



Note!

Setting RDG KNX parameters is only supported by the following tool versions:

- ETS3f or higher
- ACS700 version 5.11 or higher



Inputs and outputs identified by this symbol communicate with other KNX devices. They are called communication objects (CO).

The communication objects of the RDG KNX thermostats work partly in S-mode, partly in LTE mode, and partly in both. These objects are described accordingly.

A list of the parameters is shown in section 3.12.

2. Summary

2.1 Types

Product no.	Stock number	Features					Backlit LCD
		Operating voltage	Number of control outputs				
			ON/OFF	PWM	3-pos	DC 0...10 V	
RDG400KN	S55770-T165	AC 24 V	1 ¹⁾	1 ¹⁾	1 ¹⁾	1	✓

1) Selectable: ON/OFF, PWM or 3-position (triac outputs)

2.2 Ordering

- When ordering, please indicate both product no. / stock no. and name:
E.g. **RDG400KN / S55770-T165 room thermostat**
- Order valve actuators separately

2.3 Functions

Use

VAV systems via ON/OFF or modulating control outputs:

- Single-duct system
- Single-duct system with electric heater
- Single-duct system and radiator / floor heating
- Single-duct system with heating / cooling coil

The room thermostats are delivered with a fixed set of applications.
The relevant application is selected and activated during commissioning using one of the following tools:

- Synco ACS
- ETS3 Professional
Parameter and application download with ETS3 will be implemented later
- Local DIP switch and HMI

Features

- Operating modes: Comfort, Economy (Energy Saving) and Protection
- Output for VAV box / damper: DC 0...10 V / 3-position (triac)
- Output for heating / cooling coil: ON/OFF, PWM or 3-pos (triac) / DC 0..10V
- Output signal inversion as an option (DC 0...10 V → DC 10...0 V)
- Automatic or manual heating / cooling changeover
- Backlit display
- AC 24 V operating voltage

Functions

- Room temperature control via built-in temperature sensor or external room temperature / return air temperature sensor
- Changeover between heating and cooling mode (automatic via local sensor or bus, or manually)
- Selection of applications via DIP switches or commissioning tool (ACS700).
Parameter and application download with ETS3 will be implemented later
- Select operating mode via operating mode button on the thermostat

- Temporary Comfort mode extension
- Display of current room temperature or setpoint in °C and/or °F
- Display of outdoor temperature or time of day via KNX bus
- Minimum and maximum limitation of room temperature setpoint
- Minimum and maximum limitation of air flow signal DC 0...10 V
- Button lock (automatically or manually)
- 2 multifunctional inputs, freely selectable for:
 - Operating mode switchover contact (keycard, window contact, etc.)
 - Sensor for automatic heating / cooling changeover
 - External room temperature or return air temperature sensor
 - Dew point sensor
 - Electric heater enable
 - Fault input
 - Monitor input for temperature sensor or switch state
- 1 DC 0...10 V input for damper position feedback
- Floor heating temperature limitation
- Reload factory settings for commissioning and control parameters

2.4 Integration via KNX bus

The RDG room thermostats can be integrated as follows:

- Integration into Synco 700 system via LTE mode (easy engineering)
- Integration into Synco living via group addressing (ETS3)
- Integration into DESIGO via group addressing (ETS3) or individual addressing
- Integration into third-party systems via group addressing (ETS3)

The following KNX functions are available:

- Central time program and setpoints, e.g. when using the RMB795 central control unit
- Outside temperature or time of day via bus displayed on thermostat
- Remote operation and monitoring, e.g. using the RMZ792 bus operator unit
- Remote operation and monitoring with web browser using the OZW772 or OZW775 web server
- Maximum energy efficiency due to exchange of relevant energy information, e.g. with Synco 700 controllers (e.g. heating demand, cooling demand)
- Alarming, e.g. external fault contact, condensation, etc.
- Monitoring input for temperature sensor or switch

Engineering and commissioning can be done using...

- local DIP switches / HMI
- Synco ACS700 service tool
- ETS3 Professional

Parameter and application download with ETS3 will be implemented later

Synco 700

The RDG room thermostats are especially tailored for integration into the Synco 700 system and operate together in LTE mode. This extends the field of use of Synco for individual room control in conjunction with fan coil units, VAV, chilled ceilings and radiators.

Synco living

Thanks to S-mode extension to the QAX910 central apartment unit, communicating room thermostats can be easily integrated into Synco living systems. Using the S-mode data points of the central apartment unit, additional room information can be exchanged with the room thermostat via KNX TP1 (RF function is not available on the room thermostats). To make the integration, the ETS3 engineering tool is required.

Synco topology

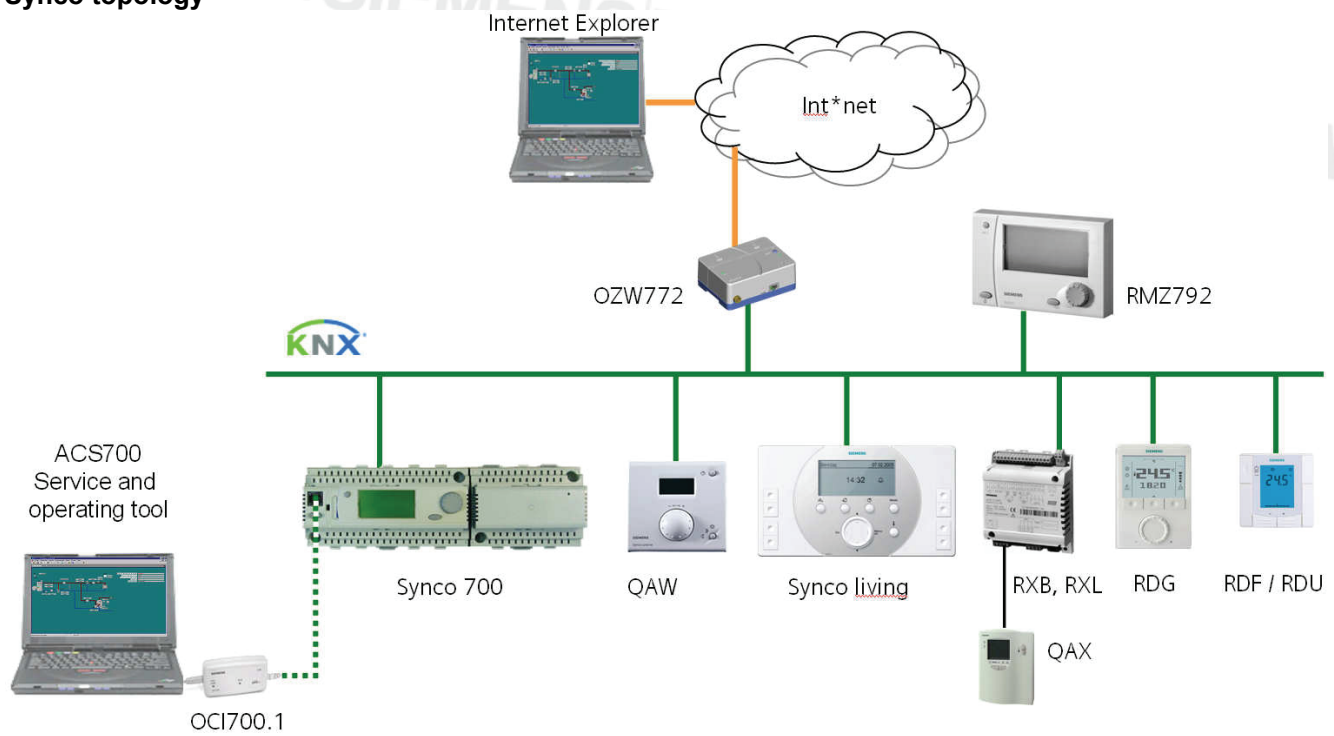















Legend:









Synco 700	Building automation and control system (BACS)
Synco living	Room automation and control system
RDG..., RDF..., RDU...	Room thermostats
OZW772 (or OZW775)	Web server
RMZ792	Bus operator unit
QAW...	Room unit
ACS700	Service tool using OCI700.1 (OCI700.1 is delivered with a service cable which can be plugged into the service connector on a Synco controller)
RXB, RXL	Room controllers
QAX	Room unit for RXB / RXL room controllers

DESIGO and third-party systems

The RDG KNX devices can be integrated into the Siemens building automation and control systems (BACS) DESIGO or into 3rd-party systems. For integration, either S-mode (group addressing) or individual addressing can be used. The workflow for integration into DESIGO is the same as with standard KNX devices.

2.5 Equipment combinations

Type of unit		Product no.	Data sheet	
Cable temperature sensor		QAH11.1	1840	
Room temperature sensor		QAA32	1747	
Condensation detector / Supply unit		QXA2000 / QXA2001 / AQX2000	1542	
Electrical actuator, DC 0..10 V (for radiator valve)		SSA61...	4893	
Electrical actuator, DC 0..10 V (for 2 and 3 port valves / V...P45)		SSC61...	4895	
Electrical actuator, DC 0..10 V (for small valve 2,5 mm)		SSP61...	4864	
Electrical actuator, DC 0..10 V (for small valves 5.5 mm)		SSB61...	4891	
Electrical actuator, DC 0..10 V (for Combi-valve VPI45)		SSD61...	4861	
Electromotoric actuator, DC 0..10V (for valves 5.5 mm)		SQS65...	4573	
Thermal actuator, DC 0..10 V (for small valves and radiator valves)		STS61	4880	
DC 0..10 V and 3-pos damper actuators		GQD161... GQD131...	4605	
		GDB161... GDB131... GLB161... GLB131...	4634	
			GMA161... GMA131...	4614
			GEB161... GEB131...	4621
			GCA161... GCA131...	4613
	GBB161... GBB131...		4626	
				GIB161... GIB131...
	VAV compact controller			GDB181.1E/3
		GLB181.1E/3		

ON/OFF valve actuators AC 24 V	Electromotoric ON/OFF valve and actuator <i>(only available in AP, UAE, SA and IN)</i>		MVI.../MXI...	4867
	Electromotoric ON/OFF actuator		SFA71...	4863
ON/OFF / PWM valve actuators AC 24 V *)	Thermal actuator (for radiator valve)		STA71...	4877
	Thermal actuator (for small valves 2.5 mm)		STP71...	4878
3-position valve actuators AC 24 V	Electrical actuator, 3-position (for radiator valve)		SSA81...	4893
	Electrical actuator, 3-position (for small valve 2,5 mm)		SSP81...	4864
	Electrical actuator, 3-position (for small valve 5,5 mm)		SSB81...	4891
	Electrical actuator, 3-position (for Combi-valve VPI45)		SSD81...	4861
	Electromotoric actuator, 3-position (for valves 5.5 mm)		SQS85...	4573

*) With PWM control, it is not possible to ensure exact parallel running of more than one thermal actuator. If several actuators are controlled by the same room thermostat, preference should be given to motorized actuators with ON/OFF or 3-position control.

2.6 Accessories

Description	Product no / Stock no.	Data sheet
Changeover mounting kit (50 pcs / package)	ARG86.3	N3009
Adapter plate 120 x 120 mm for 4" x 4" conduit boxes	ARG70	N3009
Adapter plate 112 x 130 mm for surface wiring	ARG70.2	N3009
KNX power supply 160 mA (Siemens BT LV)	5WG1 125-1AB01	--
KNX power supply 320 mA (Siemens BT LV)	5WG1 125-1AB11	--
KNX power supply 640 mA (Siemens BT LV)	5WG1 125-1AB21	--

3. Functions

3.1 Temperature control

General note: Parameters

Setting of the control parameters (P01, etc., mentioned throughout the document) is described in section 3.12.

Temperature control

The thermostat acquires the room temperature via built-in sensor, external room temperature sensor (QAA32), or external return air temperature sensor (QAH11.1), and maintains the setpoint by delivering actuator control commands to heating and/or cooling equipment. The following control outputs are available:

- VAV box / damper:
Modulating PI/P control with DC 0...10 V / 3-position
- Heating / cooling coil, radiator, el. heater:
Modulating PI/P control with 3-position / PWM / DC 0...10 V / ON/OFF control (2-position)

The switching differential or proportional band is 2 K for heating mode and 1 K for cooling mode (adjustable via parameters P30 and P31).

The integral action time for modulating PI control is 5 minutes (adjustable via parameter P35).

Display







The display shows the acquired room temperature or the Comfort setpoint, selectable via parameter P06. The factory setting displays the current room temperature. Use parameter P04 to display the room temperature or setpoint in °F rather than °C as needed.

The acquired room temperature (internal or external sensor) is also available as information on the bus.



Room temperature



- With automatic changeover or continuous heating / cooling, symbols  /  indicate that the system currently heats or cools (heating or cooling output is activated).
- With manual changeover (P01 = 2), symbols  /  indicate that the system currently operates in heating or cooling mode. Thus, the symbols are displayed even when the thermostat operates in the neutral zone.
Symbols   indicate that the system currently heats or cools (heating or cooling output is activated).

Concurrent display of
°C and °F

Concurrent display of the current temperature or setpoint in °C and °F (parameter P07 = 1) is possible on the thermostats.



Outside temperature via
bus

The outside temperature can be displayed on the room thermostat by setting parameter P07 = 2. This temperature value has only information character. In LTE mode, the outside temperature can only be received on outside temperature zone 1.

In S-mode, the corresponding communication object needs to be bound with a KNX sensor device.



Time of day via bus

Time of day via bus can be displayed on the room thermostat by setting parameter P07 = 3 or 4. The display format is either in 12- or in 24-hour format.

The information can be received from a Synco controller with time master functionality or any other KNX device if the corresponding communication object is bound.

3.2 Operating modes

The thermostat's operating mode can be influenced in different ways (see below). Specific heating and cooling setpoints are assigned to each operating mode.

The thermostat sends the effective room operating mode on the bus.

The following operating modes are available:



Room operating mode:
State

Auto Timer 

In Auto Timer mode the room operating mode is commanded via bus. Auto Timer is replaced by Comfort when no time schedule via bus is present

Comfort 

In Comfort mode, the thermostat maintains the Comfort setpoint. This setpoint can be defined via parameters P8, P9 and P10. It can be locally adjusted via the rotary knob or via bus. In Comfort mode, the fan can be set to automatic or manual fan speed: Low, medium or high.

Economy 

The setpoints (less heating and cooling than in Comfort mode) can be defined via parameters P11 and P12.

The thermostat switches to Economy mode when...

- the operating mode button is pressed (only possible if parameter P02 is set to 2)
- Economy is sent via bus
- an operating mode switchover contact (e.g. keycard contact presence detector, window contact) is active.

The contact can be connected to digital input D1 or multifunctional input X1. Set parameter P38 / P42 to 3 (P02 is irrelevant) *)



- "Window state" is sent via bus, e.g. from a KNX switch or a KNX presence detector (P02 is irrelevant) *)

Note: *) Operating mode switchover: *Only one input source must be used, either local input X1/ D1 or KNX bus. User operations are ineffective and "OFF" is displayed if the operating mode switchover contact is active, or if "Window state" is sent via bus.*

Protection 



In Protection mode, the system is...

- protected against frost (factory setting 8 °C, can be disabled or changed via P65)
- protected against overheating (factory setting OFF, can be enabled or changed via P66)

No other operating mode can be selected locally if Protection mode is commanded via bus.  and  are displayed.

3.2.1 Different ways to influence the operating mode

Source for change of operating mode

-  ACS Service
-  ACS Operating

The operating mode can be influenced by different interventions. The source of the effective room operating mode state can be monitored using the "Cause" diagnostic data point in the ACS700 tool, operator unit RMZ792 or web server OZW772 / 775.





Source	Description	Value of DP "Cause"
Local operation via left button	<ul style="list-style-type: none"> • Operating mode is not Auto Timer • No time schedule via bus 	Room operating mode selector (preselection)
	<ul style="list-style-type: none"> • Temporary Comfort extension is active 	"Timer" function
	<ul style="list-style-type: none"> • Operating mode switchover contact 	Room operating mode contact
 Bus command Room op. mode	<ul style="list-style-type: none"> • "Window state" sent via bus 	Room operating mode contact
	<ul style="list-style-type: none"> • Time schedule available via bus → local operating mode is set to Auto Timer 	Time switch
	<ul style="list-style-type: none"> • Time schedule sends Protection mode via bus → operating mode cannot be changed locally 	

Priority of operating mode interventions

The following table shows the priorities of different interventions. A lower number means a higher priority.

Priority	Description	Remark
①	Commissioning	In parameter setting mode (highest priority), you can always command an operating mode independent of all other settings or intervention via bus and local input.
②	Protection mode via bus from time schedule	Protection mode, sent by a time schedule, has priority 2. It cannot be overridden by the user nor by an operating mode switchover contact.
③	Operating mode switchover contact	If the contact is closed, the operating mode changes to Economy. This overrides the operating mode on the thermostat.
③	"Window state" via bus	"Window state" sent via bus has the same effect as the operating mode switchover contact. <i>Note: Only one input source must be used, either local input X1 / D1 or KNX bus.</i>
④a	Operating mode button	The user can switch the operating mode using the operating mode button.
④b	Operating mode via bus	The operating mode can be changed via bus
④c	Temporary extended Comfort mode via operating mode button	The operating mode can be temporarily set from Economy to Comfort by pressing the operating mode button, if... – Economy was sent via bus – extended Comfort period >0 (parameter P68) <i>The last intervention wins, either locally or via bus</i>
⑤	Time schedule via bus	The operating mode sent via bus can be overridden by all other interventions. <i>Exception: Protection mode has priority 2.</i>

Auto Timer mode with time schedule via bus

If a time schedule via bus is present, e.g. from central control unit, then the Auto Timer mode  is active. The thermostat automatically changes between Comfort and Economy according to the time schedule via bus. The display shows the Auto Timer mode symbol  along with the symbol for the effective room operating mode (Comfort  or Economy ). By pressing the operating mode button, you can change to another operating mode. Automatic fan is the default fan speed in Auto Timer mode.

Behavior when bus sends new operating mode

Each time the time schedule sends a new operating mode (switching event), the operating mode of the thermostat is set back to Auto Timer mode. This is to assure that the room temperature is maintained according to the time schedule.

Precomfort via bus











If the time schedule sends Precomfort mode, then this mode will be transformed either into Economy (factory setting) or Comfort (selectable via parameter P88).

Behavior when bus sends Protection

No intervention is possible neither by the user nor by an operating mode switch-over contact, if Protection mode is set by the time schedule. OFF flashes on the display when the user presses a button.

Availability of Economy mode

The operating mode can be selected locally via the operating mode button. The behavior of the operating mode button (user profile) can be defined via parameter P02, factory setting is P02 = 1.

P02	Without time schedule	With time schedule via bus	Description
1	 → 	 → 	<ul style="list-style-type: none"> Switching manually between 2 modes, Economy is not available (factory setting) Suited for hotel guest rooms or commercial buildings. If a time schedule via bus is available, then the Comfort mode can be temporarily extended (see below)
2	 →  → 	 →  →  → 	<ul style="list-style-type: none"> Switching manually between 3 modes Suited for homes and rooms where manual switching to Economy mode is desired

Operating mode switchover contact (window contact)

The thermostat can be forced into Economy mode (e.g. when a window is opened, when a presence detector signals "no one present", when the keycard of a hotel room is withdrawn, etc). The contact can be connected to digital input D1 (or multi-functional input X1). Set parameter P42 (P38) to 3.

If the operating mode switchover contact is active, pressing the left button will show "OFF" (blinking).



Room operating mode:
Window state

The function is also available via the KNX signal "Window state", e.g. from a KNX switch or a KNX presence detector.

Note: Only one input source must be used, either local input X1 / D1 or KNX bus. User operations are ineffective and "OFF" is displayed if the operating mode switchover contact is active, or if "Window state" is sent via bus.

Temporary timer to extend the Comfort mode

Comfort mode can be temporarily extended (e.g. working after business hour or on weekends) when the thermostat is commanded to Economy mode by a central time switch, operating mode switchover via KNX or via local input X1, D1. The operating mode button switches the operating mode back to Comfort for the period preset in P68. Press the operating mode button again to stop the timer.

The following conditions must be fulfilled:

- Mode selection via operating mode button is set to "Protection-Auto" (P02 = 1) and parameter P68 (extend Comfort period) is greater than 0
- The time schedule via bus is Economy or Operating mode switchover is active

During the temporary Comfort mode extension, symbol  appears.

If parameter P68 (extend Comfort period) = 0, extended Comfort cannot be activated; pressing the left button will switch the thermostat to Protection.

Timer for extension of presence / absence



The effective room operating mode can be forced temporarily into Comfort or Economy / Protection mode. The time period is adjusted via the rotary knob:

- Extend presence: Set the device to Comfort mode for the selected time period
- Extend absence: Set the device to Economy / Protection mode for the selected time period

To activate the function, keep the left button pressed and, within 3 seconds, turn the rotary knob...

- clockwise for extended presence
- counterclockwise for extended absence

The rotary knob adjusts the time period:

- Extend presence: 0:00...+9:30 in steps of 30 minutes; symbol  appears
- Extend absence: 0:00...-9:30 in steps of 30 minutes; symbol  or  appears

During the extended presence / absence period, the sandglass symbol  appears.

Function if no time schedule is received via bus

User profile for operating mode (selected via P02)	Operating mode when activating function	Function	Operating mode during function	Operating mode at the end of function
P02 = 1 → ☀ → ⌚ → ☀ → ⌚ → ⌚ → ⌚ → ⌚ → ⌚	Comfort	Extension	Comfort	Protection
	Comfort	Absence	Protection	Comfort
	Protection	Not available	-	-
P02 = 2 → ☀ → ⌚ → ☀ → ⌚ → ⌚ → ⌚ → ⌚ → ⌚ → ⌚ → ⌚ → ⌚ → ⌚	Comfort	Extension	Comfort	Economy
	Comfort	Absence	Economy	Comfort
	Economy	Extension	Comfort	Economy
	Economy	Absence	Economy	Comfort
	Protection	Not available	-	-

Function with time schedule via bus

User profile for operating mode (selected via P02)	Operating mode when activating function	Function	Operating mode during function	Operating mode at the end of function
P02 = 1 → ⌚ → ☀ → ⌚ → ⌚ → ⌚ → ⌚ → ⌚ → ⌚ → ⌚ → ⌚ → ⌚ → ⌚	Auto	Extension	Comfort	Auto
	Auto	Absence	Protection	Auto
	Comfort	Extension	Comfort	Auto
	Comfort	Absence	Protection	Auto
	Protection	Not available	-	-
P02 = 2 → ⌚ → ☀ → ⌚ → ⌚	Economy	Extension	Comfort	Auto
	Economy	Absence	Economy	Auto
	Protection	Not available	-	-

3.2.2 Communication examples

The following examples show two typical applications of a central time schedule in conjunction with local control of the room operating mode.

The room operating mode in rooms 1...2 of a building is determined by the time schedule. Window contacts are fitted in all rooms.

The following conditions are specified:

The rooms are used and controlled by the time schedule as follows:

- Night setback from 17:00 to 08:00 (Economy)
- Protection from 20:00 to 06:00
- Lunch break from 12:00 to 13:00 (Precomfort)

The substitution (parameter P88) for Precomfort via bus is set on the thermostats as follows:

- Room 1: Comfort (1)
- Room 2: Economy (0)

Example 1

Operating mode switchover

In **room 1**, the window is opened briefly, once in the morning, once in late afternoon and once at night (1). Only the opening in the morning has a direct impact on the effective room operating mode.

During lunch break, the time schedule changes to Precomfort. The mode remains in Comfort as set by parameter "Transformation Precomfort" (P88 = 1).

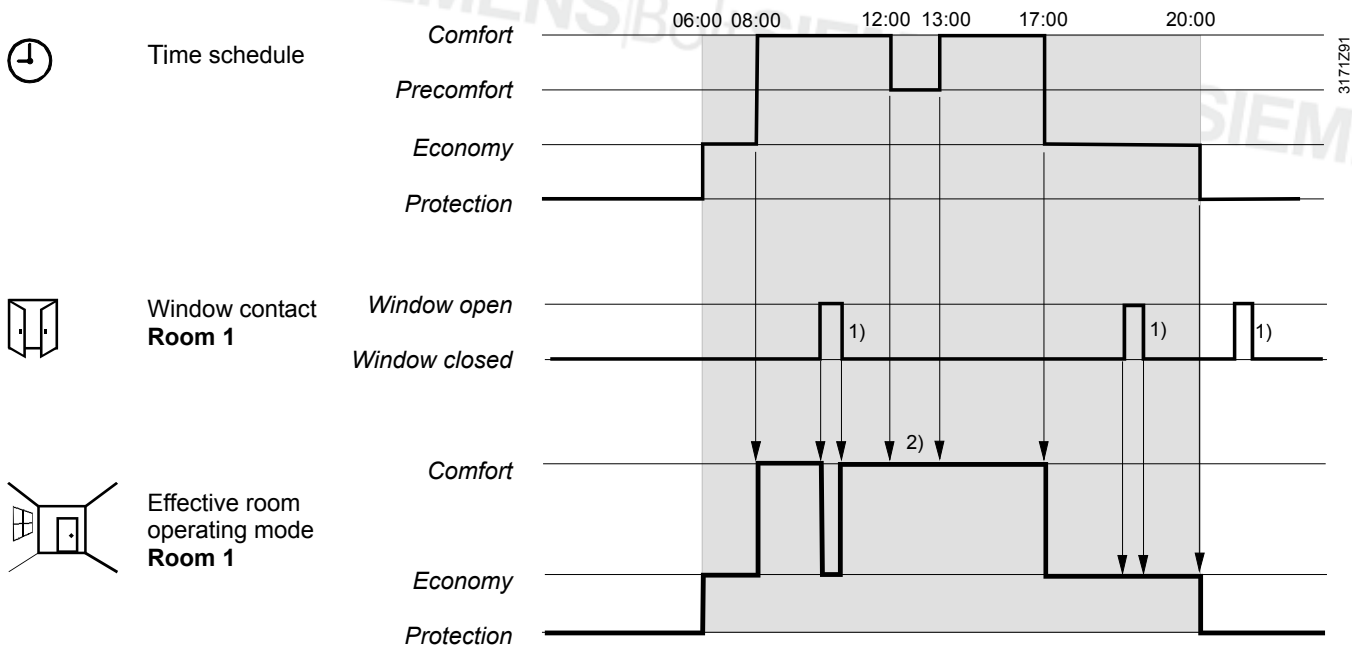

Example 2

Interaction of user operation (operating mode button) and central time schedule

In **room 2**, the window is opened briefly, once in the morning and once at night (1). Only the opening in the morning has a direct impact on the effective room operating mode.

With the operating mode button, the operating mode can be changed between OFF and Auto or temporary Comfort extension respectively.

- During lunch break, the time schedule changes to Precomfort. The mode of the thermostat changes to Economy as set by parameter "Transformation Precomfort" (P88 = 0) (6)
- During lunch break, the user changes the operating mode to Comfort (temporary Comfort extension) by pressing the operating mode button (2). At 13:00, the timer is reset due to mode change of the central time schedule
- In the afternoon, the user switches the thermostat off by pressing the operating mode button (3). At 17:00 the user setting is reset to Economy by the time schedule
- At 19:30, the user again extends the Comfort mode (4). At 20:00, the timer is reset by the time schedule
- After 20:00, pressing the operating mode button has no effect, as the central time switch sets the thermostat to Protection (5)

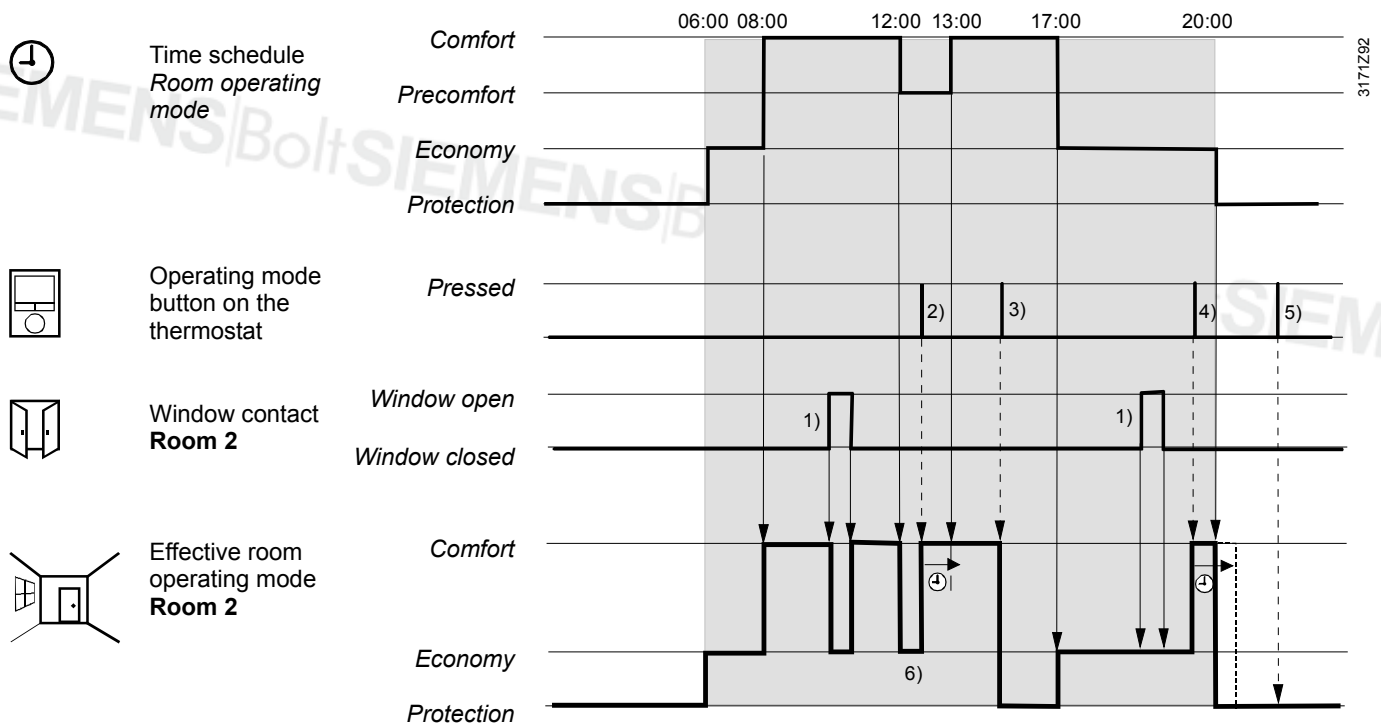

3.3 Room temperature setpoints

3.3.1 Description

Comfort mode

The factory setting for the Comfort basic setpoint is **21 °C** and can be changed in the thermostat's EEPROM via parameter P08 or via bus with communication object " Comfort basic setpoint". The last intervention always wins.

The Comfort setpoint can be adjusted via the, rotary knob, or via bus from a remote device like a touchpanel, operating unit, etc. The last intervention always wins.

Temporary setpoint

If the "Temporary setpoint" function is enabled via parameter P69, the Comfort setpoint adjusted via the rotary knob, or via bus is set back to the Comfort basic setpoint stored in P08 when the operating mode changes.

Setpoint limitation

For energy saving purposes, the setpoint setting range can be limited to minimum (P09) and maximum (P10).

P09 < P10

- If the minimum limit **P09 is set lower** than the maximum limit P10, both heating and cooling are adjustable between these 2 limits

P09 ≥ P10

- For heating **or** cooling applications (e.g. single duct):
 - The setting range in cooling mode is from **P09...40 °C** in place of 5...40 °C
 - The setting range in heating mode is from **5...P10 °C** in place of 5...40 °C
- For heating **and** cooling applications (e.g. single duct with el. heater):
 - **P09** is the setpoint for cooling and **P10** the setpoint for heating
 - The setpoint can no longer be adjusted via the rotary knob

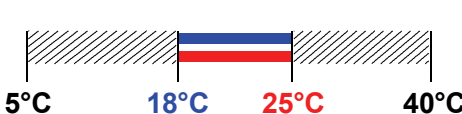
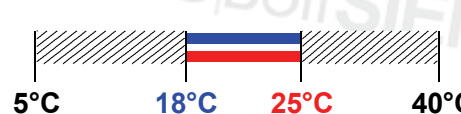
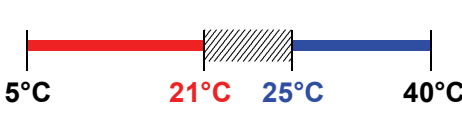
Examples	Single duct Heating OR cooling	Single duct & el. heater Heating AND cooling
P09 < P10	 <p>5°C 18°C 25°C 40°C P09 P10</p> <p>Cooling setpoint adjustable 18...25 °C Heating setpoint adjustable 18...25 °C</p>	 <p>5°C 18°C 25°C 40°C P09 P10</p> <p>Cooling setpoint adjustable 18...25 °C Heating setpoint adjustable 18...25 °C</p>
P09 ≥ P10	 <p>5°C 21°C 25°C 40°C P10 P09</p> <p>Cooling setpoint adjustable 25...40 °C Heating setpoint adjustable 5...21 °C</p>	<p>Cooling fixed = 25 °C (P09) Heating fixed = 21 °C (P10)</p>

Economy mode

Use control parameters P11 and P12 to adjust the Economy mode setpoints. The heating setpoint is factory-set to **15 °C**, and the cooling setpoint to **30 °C**.

Protection mode

Use control parameters P65 and P66 to adjust the Protection mode setpoints. The heating setpoint is factory-set to **8 °C** (frost protection) and to **OFF** for cooling.

Caution ⚠

If a setpoint (Economy or Protection) is set to OFF, the thermostat does not control the room temperature in the corresponding mode (heating or cooling). This means no protective heating or cooling function and thus risk of frost in heating mode or risk of overtemperature in cooling mode!

The Economy setpoints are accessible at the service level (P11, P12); the Protection setpoints at the expert level (P65, P66).

3.3.2 Setting and adjusting setpoints

Room temperature setpoints can be

- set during commissioning
- adjusted during runtime

The source can be

- the local HMI
- a tool
- a central control unit

The thermostat stores the setpoints

- in EEPROM in the form of parameters
- in the runtime memory

The table below shows the interrelations:



Comfort basic setpoint
Comfort setpoint

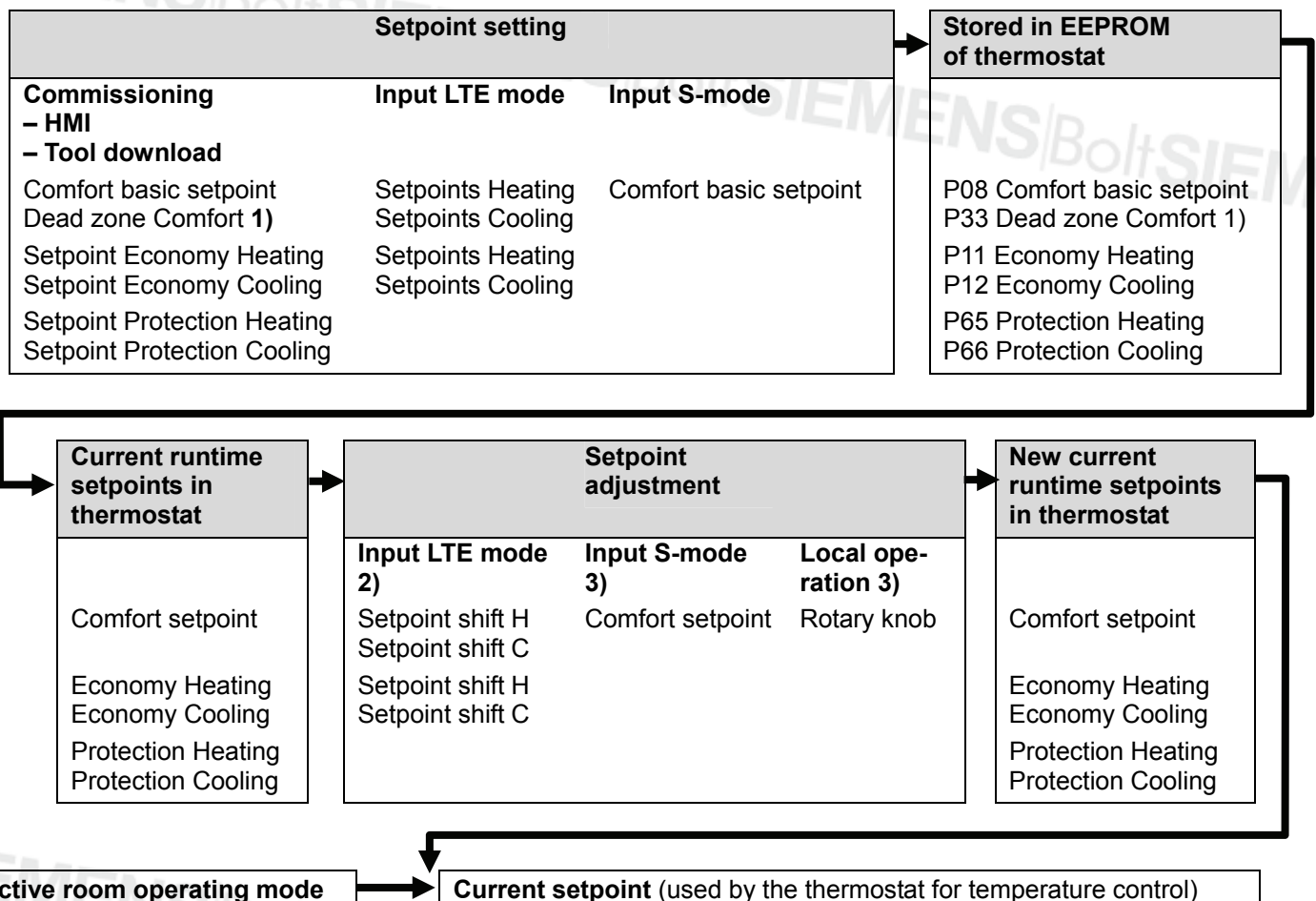

- 1) Only required for heating AND cooling applications (see section 3.6.8)
- 2) **The shift is added** to the local shift (LTE mode only)
- 3) **The last intervention wins**, either S-Mode input or local operation



Current setpoint

The current setpoint (used by the thermostat for temperature control) is available on the bus for use in the central control unit.

General notes:

- The supported communication objects are different in LTE mode and S-mode
- Changes via the local HMI or via KNX have the same priority (last always wins)
- Adjusting the Comfort basic setpoint will reset the runtime Comfort setpoint to the basic setpoint

Notes on setpoint adjustment (LTE mode with Synco only)

- Central setpoint shift is used for summer / winter compensation in particular
- Setpoint shift does not affect the setpoints stored in parameters P08, P11, P12, P33
- Local shift and central shift are added together
- Applies only to Comfort and Economy setpoints; Protection setpoints are not shifted centrally
- The resulting (current) setpoint heating and cooling is limited by the Protection setpoint; if Protection setpoint is OFF, then minimum 5 °C and maximum 40 °C are used
- The resulting setpoints for cooling and heating of the same operating mode have a minimum distance of 0.5 K between them
- The result of local and central shift, together with the room operating mode, is used by the thermostat for temperature control (current setpoint)

3.4 Applications overview

The thermostats support the following applications, which can be configured using the DIP switches at the rear of the unit or a commissioning tool.

DIP switches 1...3 need to be set to OFF (remote configuration, factory setting) to select an application via commissioning tool. In this case the output signal type needs to be set in ACS as well.

The tool offers the applications printed in bold text (basic applications).

Application	DIP switches
Remote configuration via commissioning tool (factory setting) <ul style="list-style-type: none"> • Synco ACS • ETS3 professional (planned) 	
Single-duct <ul style="list-style-type: none"> • DC 0...10 V damper actuator (P47 = 0) • 3-position damper actuator (P47 = 1) 	
Single-duct with electric heater <ul style="list-style-type: none"> • DC 0...10 V damper actuator and ON/OFF, PWM or 3-position electric heater (P47 = 0) • 3-position damper actuator and DC 0...10 V electric heater (P47 = 1) 	
Single-duct and radiator / floor heating <ul style="list-style-type: none"> • DC 0...10 V damper actuator and ON/OFF, PWM or 3-position radiator (P47 = 0) • 3-position damper actuator and DC 0...10 V radiator (P47 = 1) 	
Single-duct heating and cooling coil <ul style="list-style-type: none"> • DC 0...10 V damper actuator and ON/OFF, PWM or 3-position heating and cooling (P47 = 0) • 3-position damper actuator and DC 0...10 V heating and cooling (P47 = 1) 	

Note Use P47 to change damper output from DC 0...10 V (factory setting) to 3-position
 Use P46 to change valve output from ON/OFF (factory setting) to PWM
 Use DIP switch 5 to change valve output from ON/OFF to 3-position

3.5 Additional functions

Air heating / cooling changeover



Supply air temperature

The supply air temperature sent by the primary controller indicates whether cool or warm air is supplied.

The controller determines the necessity to open or close the air damper according to the supply air temperature, the room temperature setpoint and the current room temperature.

If no Supply air temperature is available via bus, then the air changeover is cooling per default.

With application "Single duct", the changeover can also be accomplished via a local multifunctional input X1/D1 (parameter P38, P42).

Only one input source must be used, either local input X1 / D1 or KNX, and parameter "control sequence" must be set to automatic heating / cooling changeover (parameter P01 = 3).

Functionality of the local changeover input see below.

See also section 3.8 "Multifunctional input".

Water heating / cooling changeover



Heating/cooling changeover

With application "Single duct with heating / cooling coil", changeover information of the heating / cooling coil can be received either via bus or via local multifunctional input X1/D1 (parameter P38, P42).

Only one input source must be used, either local input X1/D1 or KNX and parameter "control sequence" must be set to automatic heating / cooling changeover (parameter P01 = 3).

See also section 3.8 "Multifunctional input".

In the absence of the required heating/cooling information from the bus (e.g. due to problems with data communication, power failure, etc.), the thermostat operates in the last valid operating mode (heating or cooling).

Automatic heating / cooling changeover via changeover sensor

If a cable temperature sensor (QAH11.1 + ARG86.3) is connected to X1, and parameter P38 is = 2, the water or supply air temperature acquired by the sensor is used to change over from heating to cooling mode, or vice versa. When the water / air temperature is above 28 °C (parameter P37), the thermostat changes over to heating mode, and to cooling mode when below 16 °C (parameter P36).

If the water / air temperature is between the 2 changeover points immediately after power-up, the thermostat starts in heating mode.

The water / air temperature is acquired at 30-second intervals and the operating state is updated accordingly.

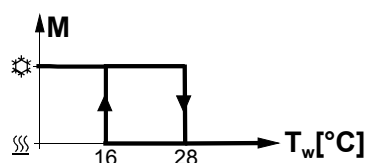

M Operating mode



Cooling mode

T_w Water temperature



Heating mode

Changeover switch

The QAH11.1 cable temperature sensor for automatic heating / cooling changeover can be replaced by an external switch for manual, remote changeover:

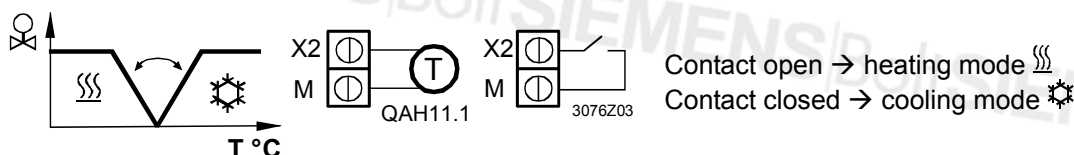

The sensor or switch can be connected to input terminal X1 or D1 (switch only), depending on the commissioning of the inputs (P38, P42). See also section 3.8 "Multifunctional input".

Manual heating / cooling changeover

If manual heating / cooling changeover is commissioned (P01 = 2), then heating / cooling mode cannot be changed via bus / changeover sensor / switch; it will remain in the last mode as selected locally via button.

External / return air temperature sensor

The thermostat acquires the room temperature via built-in sensor, external room temperature sensor (QAA32), or external return air temperature sensor (QAH11.1), connected to multifunctional input X1. Input X1 must be commissioned accordingly. See section 3.8 "Multifunctional input".

Floor temperature limitation function

The floor temperature should be limited for 2 reasons: Comfort and protection of the floor.

The floor temperature sensor, connected to multifunctional input X1, acquires the floor temperature. If the temperature exceeds the parameterized limit (parameter P51), the heating valve is fully closed until the floor temperature drops to a level 2 K below the parameterized limit.

This function is factory-set to OFF (disabled).

Input X1 or X2 must be commissioned accordingly (P38 = 1).

See section 3.8 "Multifunctional input".

Recommended values for P51:

Living rooms:

Up to 26 °C for long-time presence, up to 28 °C for short-time presence.

Bath rooms:

Up to 28 °C for long-time presence, up to 30 °C for short-time presence.

The table below shows the relation between parameter, temperature source and temperature display:

Parameter P51	External temp. sensor available	Source for display of room temperature	Output control according to	Floor temp. limit function
OFF	No	Built-in sensor	Built-in sensor	Not active
OFF	Yes	External temp. sensor	External temp. sensor	Not active
10...50 °C	No	Built-in sensor	Built-in sensor	Not active
10...50 °C	Yes	Built-in sensor	Built-in sensor + limit by external sensor	Active

Dew point monitoring

Dew point monitoring is essential to prevent condensation on the chilled ceiling. It helps avoid associated damage to the building.

A dew point sensor with a potential-free contact is connected to multifunctional input X1 or D1. If there is condensation, the cooling valve is fully closed until no more condensation is detected, and the cooling output is disabled temporarily.



Fault state

Fault information

The condensation symbol “” is displayed during temporary override and the fault “Condensation in room” will be sent via bus.

The input must be commissioned accordingly (P38, P42).

See section 3.8 “Multifunctional input”.

Button lock

If the “Button lock” function is enabled by parameter P14, the buttons will be locked or unlocked by pressing the right button for 3 seconds.

If “Auto lock” is configured, the thermostat will automatically lock the buttons 10 seconds after the last adjustment.

3.6 Control sequences

3.6.1 Sequences overview (setting via parameter P01)

The mode of the control sequence can be set via **parameter P01**. Depending on selected application it will have influences either on the air sequence or water sequence.

In all application the changeover of the air sequence can be done via supply air temperature sent by the primary controller.

The available sequences depend on the application:

Parameter	P01 = 0	P01 = 1	P01 = 2	P01 = 3			
Sequence					c/o signal on X1 / X2 / D1	c/o signal via bus	Supply air temp. via bus
Available for basic application: ↓	Heating	Cooling	Manually select heating or cooling sequence	Automatic heating / cooling changeover			
Single duct	✓	✓	✓	✓	✓ ¹⁾		✓ ¹⁾
Single duct & el heater	-	-	-	-			✓ ¹⁾
Single duct & radiator	-	-	-	-			✓ ¹⁾
Single duct & heating / cooling coil	✓	✓	✓	✓	✓ ²⁾	✓ ²⁾	✓ ¹⁾

- Notes: 1) Changeover air
2) Changeover water (heating / cooling coil)

For the relation between setpoints and sequences, see section 3.6.8.

Air sequence vs. water sequence

Application	Parameter P01 Influences the...
Single duct	Air sequence
Single duct & el heater	--
Single duct & radiator	--
Single duct & heating / cooling coil	Water sequence



Application mode

3.6.2 Application mode

The behavior of the thermostat can be influenced by a building automation and control system (BACS) via bus with the command "Application mode". With this signal, cooling and/or heating activity can be enabled or disabled. Application mode is supported in LTE mode and S-mode. The RDG KNX thermostats support the following commands:

#	Application mode	Description	Control sequence enabled
0	Auto	Thermostat automatically changes between heating and cooling	Heating and/or cooling
1	Heat	Thermostat is only allowed to heat	Heating only
2	Morning warm-up	If "Morning warm-up" is received, the room should be heated up as fast as possible (if necessary). The thermostat will only allow heating	Heating only
3	Cool	Thermostat is only allowed to provide cooling	Cooling only
4	Night purge	If "Night purge" is received, the room should be aired with cool outside air if necessary. The thermostat will open the damper and does not heat/cool with the coils or the electric heater. Function will be terminated by any operation on the thermostat.	Open damper fully if night purge condition is valid ¹⁾
5	Pre-cool	If "Pre-cool" is received, the room should be cooled down as fast as possible (if necessary). The thermostat will only allow cooling	Cooling only
6	Off	Thermostat is not controlling the outputs, which means all outputs go to off or 0%	Neither heating nor cooling
8	Emergency heat	The thermostat should heat as much as possible. The thermostat will only allow heating	Heating only
9	Fan only	All control outputs are set to 0% and only the fan is set to high speed or damper fully opened respectively. Function will be terminated by any operation on the thermostat	Open damper fully

With all other commands, the thermostat behaves like in Auto mode, i.e. heating or cooling according to demand.

1) Conditions for "Night purge" function:

- Current room temperature > Comfort cooling setpoint
- If supply air temperature via KNX is available:
Supply air temperature < current room temperature

The state (heating or cooling) of the thermostat can be monitored with the ACS700 tool (diagnostic value "Control sequence"). The last active mode is displayed when the thermostat is in the dead zone or temperature control is disabled.

Heating OR cooling

With a single-duct application, the control sequence state is determined by the application mode (see section 3.6.2) and by the state of the heating / cooling changeover signal (via local sensor or bus), or fixed according to the selected control sequence (P01 = heating (0) / cooling (1)).

Application mode (via bus)	State changeover / continuous heating or cooling	Control sequence state
Auto (0)	Heating	Heating
	Cooling	Cooling
Heat (1), (2), (8)	Heating	Heating
	Cooling	Heating
Cool (3), (5)	Heating	Cooling
	Cooling	Cooling
Night purge (4), Fan only (9)	Heating	Heating
	Cooling	Cooling

Heating AND cooling

With applications "Single duct with electric heater / radiator / heating / cooling coil", the control sequence state depends on the application mode and on the heating / cooling demand.

Application Mode (via bus)	Heating / cooling demand	Control sequence state
Auto (0)	Heating	Heating
	No demand	Heating / cooling depending on last active sequence
	Cooling	Cooling
Heat (1), (2), (8)	Heating	Heating
	No demand	Heating
	Cooling	Heating
Cool (3), (5)	Heating	Cooling
	No demand	Cooling
	Cooling	Cooling
Night purge (4), Fan only (9)	No temperature control active	Heating / cooling depending on last active sequence

The value of the output as a function of the room temperature is shown in the following diagram in case of a heating and cooling system:

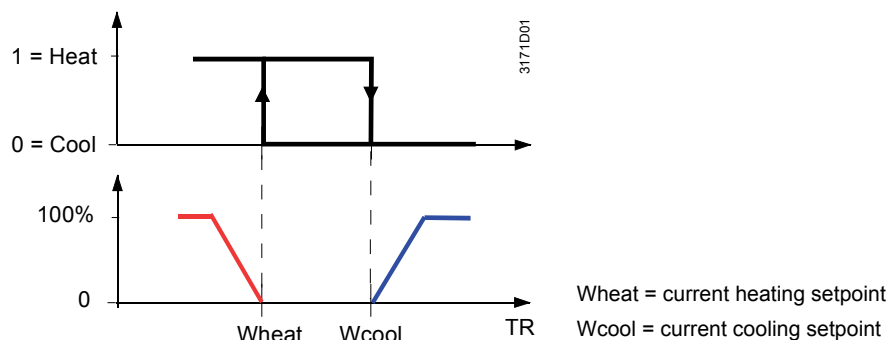

3.6.3 Minimum and maximum air volume

The factory setting for minimum and maximum air volume is 0 / 100% respectively. These values can be changed using parameters P63 / P64.

If V_{min} is greater than 0, a minimum air flow of V_{min} is assured in Comfort and Economy mode.

In Protection (or Economy mode with setpoint = OFF), V_{min} is fixed to 0.

Comfort or Economy mode

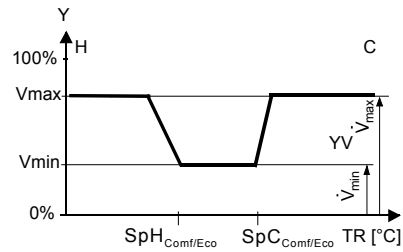

Protection mode: V_{min} always = 0

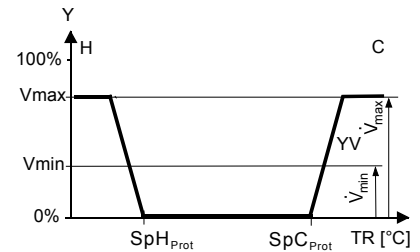

3.6.4 Single-duct

On single-duct applications, the thermostat controls an actuator (air damper, VAV system, valve etc.)...

- in heating / cooling mode with changeover (automatic or manual),
- heating only mode,
- or cooling only mode.

Cooling only is factory-set (P01=1).

The output signal for the air flow can be limited to a minimum and maximum value if required (see section 3.5 "Additional features").

Modulating control: 3-position or DC 0...10 V

The diagrams below show the control sequence for modulating PI control.

Heating only (P01 = 0)

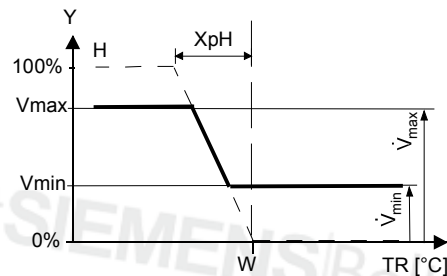

Cooling only (P01 = 1)

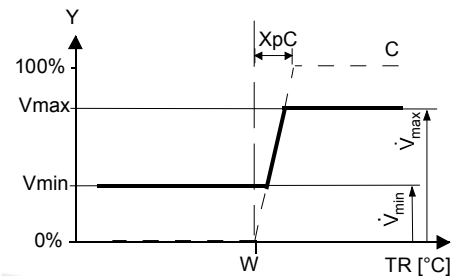

Changeover (P01 = 2, 3)

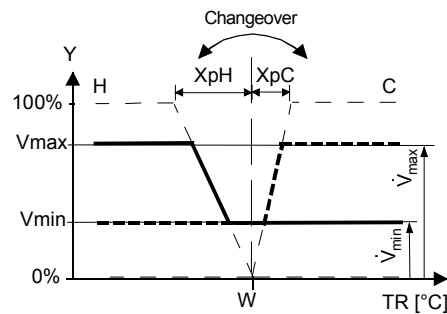

T[°C] Room temperature
w Room temperature setpoint
Y Control command "Actuator"

XpH Proportional band "Heating"
XpC Proportional band "Cooling"
Vmin Min. limitation for output
Vmax Max. limitation for output

Note: The diagrams show the PI controller's proportional part only.

Setting the sequence and the control outputs

Refer to sections 3.4 "Applications", 3.6.1 "Sequences", and 3.7 "Outputs".

3.6.5 Single-duct with electric heater

Caution 

General rule: In case of insufficient air flow, the thermostat cannot protect the electrical heater against overtemperature. Therefore the electric heater **MUST** feature a separate safety device (thermal cutout).

On single-duct applications with electrical heater, the thermostat controls a valve plus an auxiliary electrical heater. Parameter P01 is not available.

The output signal for the air flow can be limited to a minimum and maximum value if required using parameters P63 and P64. With application "Single-duct with electric heater", the min. value of P63 is overridden, so that the air flow never drops below 10 % while the electric heater is ON.

Electrical heating, active in cooling mode

The air flow starts to rise depending on the acquired room temperature, the current supply air temperature (if available) and the setpoint.

The electrical heater receives an **ON** command when the acquired room temperature drops below setpoint (= setpoint for electrical heater).

Digital input "Enable electrical heater"

Remote enabling / disabling of the electric heater is possible via input X1 or D1 for tariff regulations, energy savings, etc.

Input X1 or D1 must be commissioned accordingly (parameters P38, P42). See section 3.8 "Multifunctional input".



Enable electric heater

The electric heater can also be enabled / disabled via bus.

Note

If "Enable electric heater" input is used via bus, then the function **must not** be assigned to a local input X1 or D1.

On start-up of the controller and if the primary controller sends the information that the primary fan is off, the thermostat disables the electric heater, see section 3.10.9.

"Fan overrun time"

To avoid overheating of an electric heater when switched off, the air flow signal of Vmin must be maintained for a preset "fan overrun time" (P54, factory setting 60sec).

In conjunction with a Synco primary controller it will be assured that the primary fan keeps running during the fan overrun time.

See also section 3.10.10.

Sequences

ON/OFF electrical heater

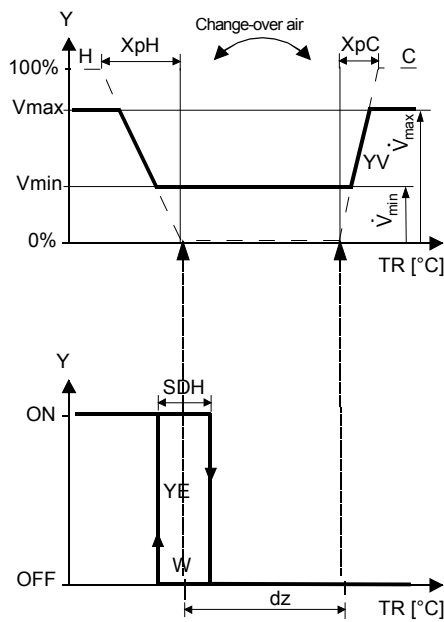

Modulating electrical heater

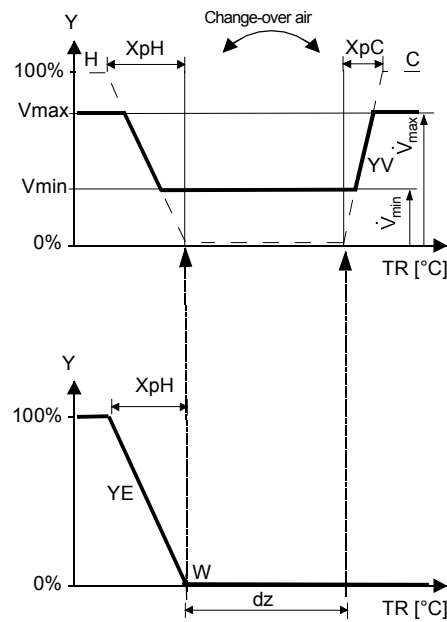

Without a valid bus signal for changeover air, the air volume is only increased for cooling:

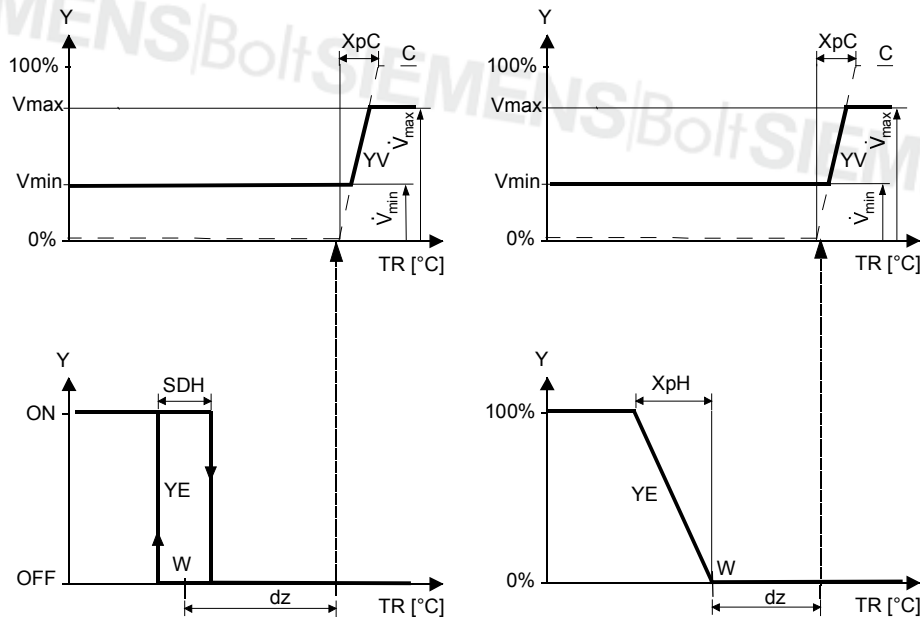

Y	Output signal
TR	Room temperature
W	Effective setpoint Comfort
H	Heating sequence
C	Cooling sequence
YV	Volume flow rate
YE	Electrical heater
XpH	Proportional band heating
XpC	Proportional band cooling
Vmin	Minimum volume output
Vmax	Maximum volume output

Note: The diagrams only show the PI thermostat's proportional part.

Setting the sequence and the control outputs

Refer to sections 3.4 "Applications", 3.6.1 "Sequences", and 3.7 "Outputs".

3.6.6 Single duct with radiator or floor heating

On single-duct applications with radiator or floor heating, the thermostat controls a valve plus an auxiliary electrical heater. Parameter P01 is not available.

The output signal for the air flow can be limited to a minimum and maximum value if required (see section 3.5 "Additional features").

Radiator, active in cooling mode

The air flow starts to rise depending on the acquired room temperature, the current supply air temperature (if available) and the setpoint.
The radiator receives an **ON** command when the acquired room temperature drops below setpoint (= setpoint for radiator).

Note: "Setpoint for radiator" is limited by parameter "Maximum heating setpoint" (P10).

Floor heating

The radiator sequence can also be used for floor heating.
The "Floor temperature limitation function" is described on page 26.

Sequences

2-position radiator / floor heating

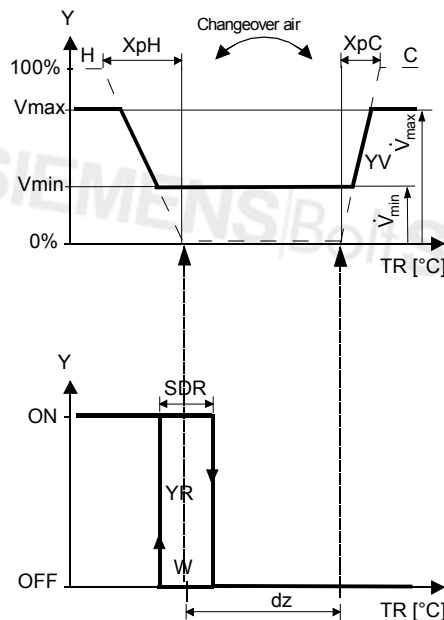

Y Output signal
TR Room temperature
W Effective setpoint Comfort
H Heating sequence
C Cooling sequence
YV Volume flow rate
YR Radiator / floor heating

Modulating radiator / floor heating

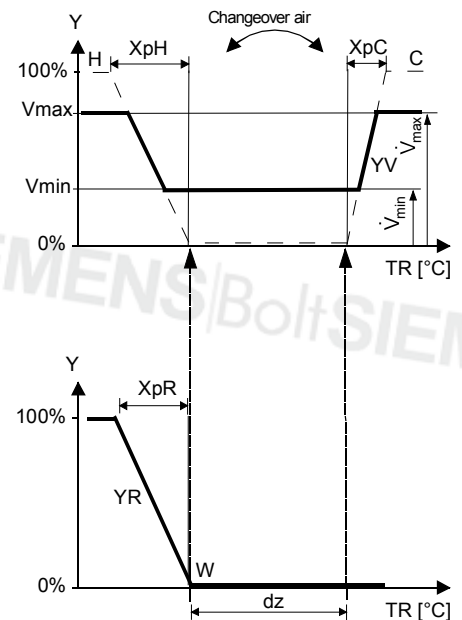

XpH Proportional band heating
XpC Proportional band cooling
Vmin Minimum volume output
Vmax Maximum volume output

Without a valid bus signal for changeover air, the air volume is only increased for cooling:

2-position radiator / floor heating

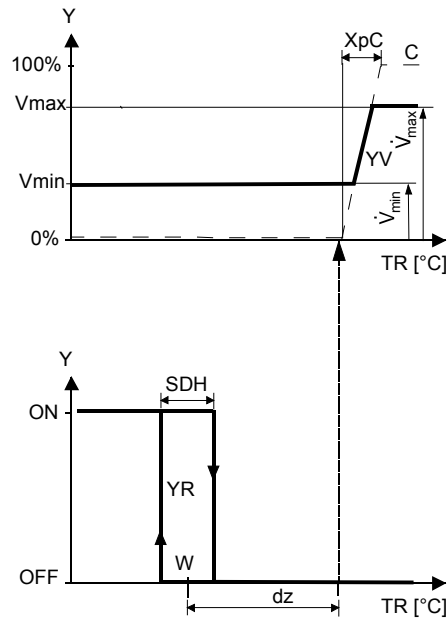

Y Output signal
 TR Room temperature
 W Effective setpoint Comfort
 H Heating sequence
 C Cooling sequence
 YV Volume flow rate
 YR Radiator / floor heating

Modulating radiator / floor heating

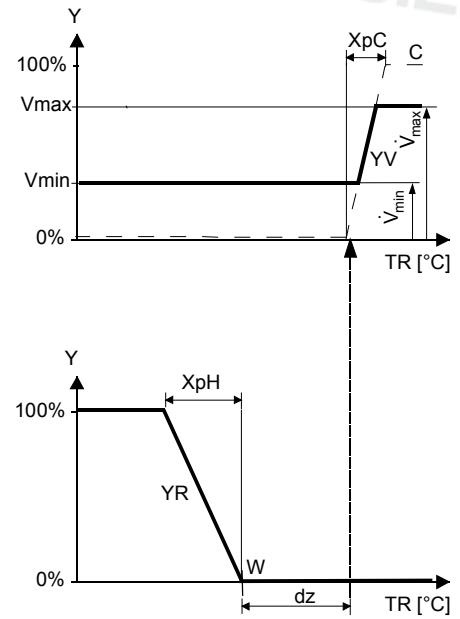

XpH Proportional band heating
 XpC Proportional band cooling
 Vmin Minimum volume output
 Vmax Maximum volume output

Note: The diagrams show the PI controller's proportional part only.

Setting the sequence and the control outputs

Refer to sections 3.4 "Applications", 3.6.1 "Sequences", and 3.7 "Outputs".

3.6.7 Single-duct with heating / cooling coil

On single-duct applications with heating / cooling coil, the thermostat controls an actuator (air damper, VAV system, etc.) plus a heating / cooling water coil.

The output signal for the air flow can be limited to a minimum and maximum value if required (see section 3.5 "Additional features").

The thermostat controls the reheating / cooling water valve either in heating / cooling mode with changeover (automatic or manual), heating only, or cooling only. Cooling only is factory-set (P01 = 01).

The air flow starts to rise depending on the acquired room temperature, the current supply air temperature (if available) and the setpoint.

Water coil valve in cooling mode

If the room temperature is above the setpoint for cooling ((w)), the valve will receive an **OPEN** command and the air flow signal starts to rise to maintain the room temperature setpoint.

Water coil valve in heating mode

If the room temperature drops below the setpoint for heating (w), then the valve will receive an **OPEN** command.

Control sequence

The diagrams below show the control sequence for modulating PI control in Comfort mode.

2-position heating / cooling coil

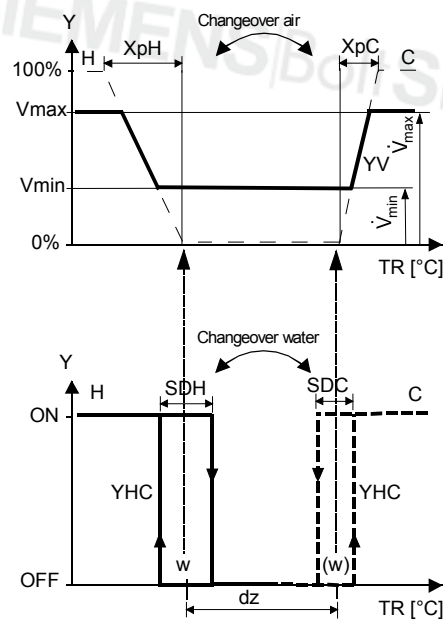

Y Output signal
 TR Room temperature
 w Comfort setpoint if changeover water = Heating
 (w) Comfort setpoint if changeover water = Cooling
 H Heating sequence
 C Cooling sequence
 YV Volume flow rate

Modulating heating / cooling coil

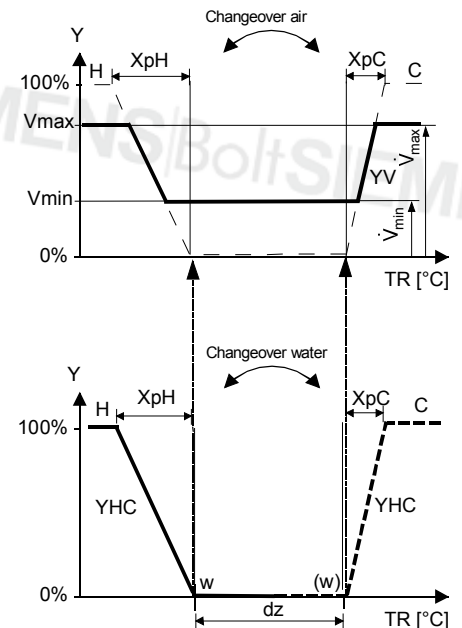

XpH Proportional band heating
 XpC Proportional band cooling
 Vmin Minimum volume output
 Vmax Maximum volume output

Without a valid bus signal for changeover air, the air volume is only increased for cooling:

2-position heating / cooling coil

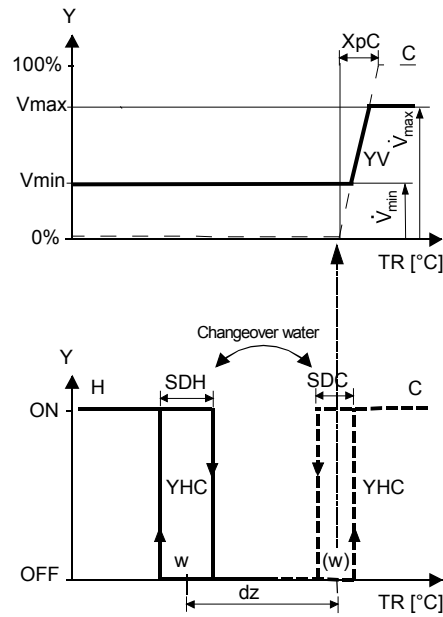

Modulating heating / cooling coil

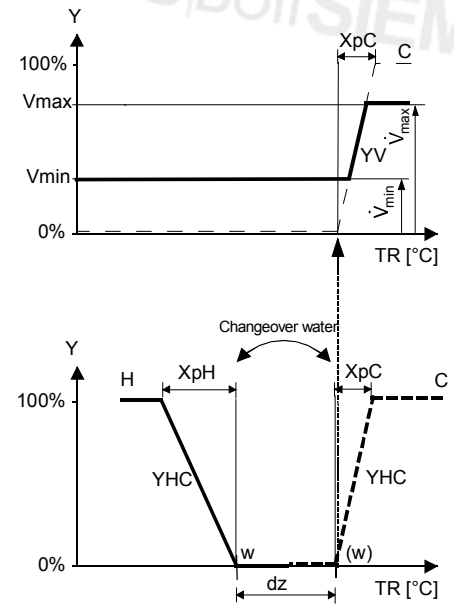

- | | | | |
|-----|--|------|---------------------------|
| Y | Output signal | XpH | Proportional band heating |
| TR | Room temperature | XpC | Proportional band cooling |
| w | Comfort setpoint if changeover water = Heating | Vmin | Minimum volume output |
| (w) | Comfort setpoint if changeover water = Cooling | Vmax | Maximum volume output |
| H | Heating sequence | | |
| C | Cooling sequence | | |
| YV | Volume flow rate | | |

Note: The diagrams show the PI controller's proportional part only.

Setting the sequence and the control outputs

Refer to sections 3.4 "Applications", 3.6.1 "Sequences", and 3.7 "Outputs".

3.6.8 Setpoints and sequences

Single duct / single duct with heating / cooling coil

- Comfort setpoint (W) is in the currently active heating or cooling sequence

Single duct with el. heater / radiator / floor heating

- Comfort setpoint (W) is in the heating sequence

Changeover air

- If the supply air temperature is available (via KNX), the air flow may also increase when the room temperature is below the heating setpoint
- If no supply air temperature is available, sequence for air flow control is Cooling only

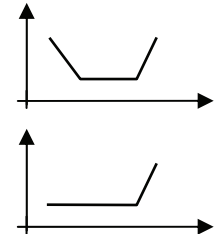

Economy, Protection

The setpoints for Economy and Protection mode are below the Comfort setpoints (heating) and above the Comfort setpoints (cooling). They can be set via parameters P11, P12 (Economy mode) and P65, P66 (Protection mode).

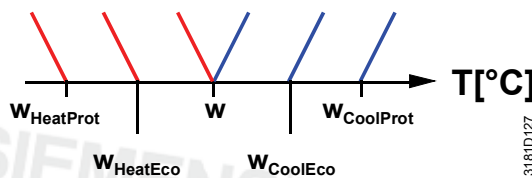

Application	Comfort mode		Economy / Protection mode	
	Heating	Cooling	Heating	Cooling
Single duct				
Single duct with heating / cooling coil				
	Heating and Cooling		Heating and Cooling	
Single duct with el. heater / radiator / floor h'g				

W = setpoint in Comfort mode

$W_{HeatEco/Prot}$ = setpoint heating in Economy or Protection mode

$W_{CoolEco/Prot}$ = setpoint cooling in Economy or Protection mode

Y = air / water sequence

T = room temperature

The dead zone can be adjusted via parameter P33.

3.7 Control outputs

3.7.1 Overview

Different control output signals are available depending on the configuration of thermostat via DIP switches 4 and 5, and parameters P46 and P47.

Control output Product No.	Modulating DC 0...10 V	2-position ON/OFF	2-position PWM	Modulating 3-position
RDG400	Y10	Y1 ¹⁾	Y1 ¹⁾	Y1/Y2 ¹⁾ (1 x ▲ / ▼)

1) Either ON/OFF, PWM or 3-position (triac)

Configuring of the control outputs: refer to section 3.7.4.

3.7.2 Control output for air flow

DC 0..10 V control signal

The demand calculated by PI control from the current room temperature and setpoint is provided to the damper actuator as a modulating DC 0...10 V signal via output Y10.

3-position control signal

A 3-position control output for an air damper has 2 control signals, one for the "opening" command and one for the "closing" command. The thermostat has an internal stroke model to calculate the position of the actuator. Therefore, the running time from the fully closed to the fully open position must be adjusted via parameter P44 (from 20...300 seconds; factory setting is 150 seconds).

Synchronization

On single-duct applications, a closing synchronization is effected to readjust the internal stroke model to the real position of the actuator.

1. When the thermostat starts up, a closing signal (actuator running time + 150% = 2.5 x running time) is delivered to ensure the actuator will be fully closed and synchronized with the control algorithm.
2. Each time the thermostat calculates the **fully closed** position, the actuator's running time is extended + 150% to ensure the right position of the actuator.
3. When the actuator has reached the position calculated by the thermostat, a waiting time of 30 seconds is observed to stabilize the outputs.

Note: "Opening" synchronization is available for valve outputs only.

3.7.3 Control output for electrical heater, radiator and heating / cooling coil

ON/OFF control signal (valve, 2-position)

The valve receives an **OPEN/ON** command via control output Y1 when...

1. the acquired room temperature is below the setpoint (heating mode) or above the setpoint (cooling mode),
2. the control outputs have been inactive for more than the "Minimum output off-time" (factory setting 1 minute, adjustable via parameter P48).

OFF command for valve output when...

1. the acquired room temperature is above the setpoint (heating mode) or below the setpoint (cooling mode),
2. the valve has been active for more than the "Minimum output on-time" (factory setting 1 minute, adjustable via parameter P49).

Electric heater control signal (2-position)

The electric heater receives an **ON** command via the auxiliary heating control output (Y1) when...

1. the acquired room temperature is below "setpoint for electric heater",
2. the electric heater has been switched off for at least 1 minute.

The **OFF** command for the electric heater is output when...

1. the acquired room temperature is above the setpoint (electric heater),
2. the electric heater has been switched on for at least 1 minute.



A safety thermostat (to prevent overheating) must be provided externally.

DC 0...10 V for electric heaters

- The demand calculated by PI control from the current room temperature and setpoint is provided via Y10 as a modulating DC 0...10 V signal
- The signal converter (SEM61.4) converts the DC 0...10 V signal to AC 24 V PDM pulses for the current valve
- The current valve (SEA45.1) supplies the electrical heater with AC 50...660 V pulsed current

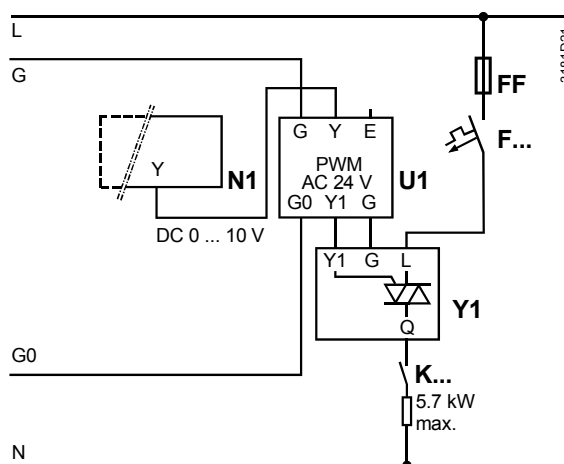

- N1 RDG400KN
- U1 Signal converter SEM61.4 (see Data Sheet N5102)
- Y1 Current valve SEA45.1 (see Data Sheet N4937)
- K... Safety loop (e.g. safety thermostat and high-temperature cutout)
- FF Very fast-acting fuse
- F... Overcurrent trip

3-position control signal

Output Y1 provides the **OPEN** command, and Y2 the **CLOSE** command to the 3-position actuator.

The factory setting for the actuator's running time is 150 seconds. It can be adjusted via parameter P44 (Y1 and Y2).

The parameter is only visible if 3-position is selected via DIP switch 5 or commissioning tool.

Synchronization

1. When the thermostat gets powered up, a closing command for the actuator's running time + 150% is provided to ensure that the actuator fully closes and synchronizes to the control algorithm.
2. When the thermostat calculates the positions "fully closed" or "fully open", the actuator's running time is extended + 150% to ensure the right actuator position synchronized to the control algorithm.
3. After the actuator reaches the position calculated by the thermostat, a waiting time of 30 seconds is applied to stabilize the outputs.

PWM control

The demand calculated by PI control from the current room temperature and set-point is provided via Y1 to the valve actuator as a PWM signal (pulse width modulation) for thermal actuators. The output is switched on for a period proportional to the heating / cooling demand and then switched off for the rest of the PWM interval.

The interval is 150 seconds (factory setting). It can be adjusted via parameter P44 (Y1). The parameter is only visible if 2-position is selected via DIP switch 5 or commissioning tool.

PWM for thermal valve actuators

For thermal valve actuators, set the running time to 240 sec.

Note!

- Never apply PWM to a motoric actuator
- It is not possible to ensure exact parallel running of more than 2 thermal valve actuators. If several fan coils are driven by the same thermostat, preference should be given to motoric actuators

PWM for electric heaters

For electrical heaters, set the running time to 90 seconds.

To avoid burn-off of mechanical contacts by frequent switching, use a current valve (e.g. SEA45.1) in place of a relay or contactor.

3.7.4 Control outputs configuration (setting via DIP switches 4/5 or tool, and parameters P46/P47)

Application ↓	Control outputs	ON/OFF (2-position)	Modulating PWM (2-position)	Modulating 3-position	Modulating DC 0...10 V
Single-duct				✓	✓
Single-duct and electrical heater		✓	✓	✓	✓
Single-duct and radiator / floor heating		✓	✓	✓	✓
Single-duct heating / cooling coil		✓	✓	✓	✓

The function of the control outputs is set via DIP switches 4 and 5:

DIP 4:	Y10 =	DC 0...10 V	DC 0...10 V	DC 10...0 V (inverted)	DC 10...0 V (inverted)
DIP 5:	Y1 / Y2 =	2-position	3-position	2-position	3-position

Notes: **Y1, Y2:**

If 2-position is selected, the factory setting is on/off.

If you want PWM (pulse width modulation), set parameter P46 to 2 = PWM.

P47:

- 0 = VAV box DC 0...10 V control signal
- 1 = VAV box: 3-position control signal

DIP switches 4 and 5 have no impact if the application is commissioned via tool. Control outputs need to be set via ACS in this case

For details concerning connection of peripheral devices and setting of the DIP switches, refer to the Mounting Instructions M3192 [3].

3.8 Multifunctional input, digital input

The thermostat has 2 multifunctional inputs X1 and a digital input D1. An NTC type sensor like the QAH11.1 (AI, analog input) or a switch (DI, digital input) can be connected to the input terminals. The functionality of the inputs can be configured via parameters P38 + P39 for X1, and P42 + P43 for D1.



The current temperature or state of the inputs X1 and D1 is available on bus for monitoring purposes.

The parameters can be set to the following values:

#	Function of input	Description	Type X1	Type DI
0	Not used	No function.	--	--
1	External / return air temperature	Sensor input for external room temperature sensor or return air temperature sensor to acquire the current room temperature, or floor heating temperature sensor to limit the heating output. <i>Note:</i> The room temperature is acquired by the built-in sensor if the floor temperature limitation function is enabled via parameter P51.	AI	--
2	Heating / cooling changeover	Sensor input for "Automatic heating / cooling changeover" function. A switch can also be connected rather than a sensor (switch closed = cooling, see section 3.5). With single-duct applications , the input changes over the air sequence; With single-duct with heating / cooling coil applications , the input changes over the water sequence (heating/cooling coil) Heating / cooling changeover is also possible via bus. ("Supply air temperature" for changeover air, "Heating/cooling changeover" for changeover water) In this case, the function must not be assigned to any local input X1, X2, D1. See also section 3.5. Diagnostic value 0 °C is displayed for closed contact / 100 °C for open contact, if a switch is connected.	AI / DI	DI
3	Operating mode switchover	Digital input to switch over the operating mode to Economy. If the operating mode switchover contact is active, user operations are ineffective and "OFF" is displayed. Operating mode switchover is also possible via bus. In this case, the function must not be assigned to any local input X1, D1. See also section 3.2.	DI	DI
4	Dew point monitor	Digital input for a dew point sensor to detect condensation. Cooling is stopped if condensation occurs.	DI	DI



Supply air temperature
Heating/
cooling
changeover



Window
state



Enable electric heater



Fault information



D1, X1 (Digital)



X1, (Temp.)

#	Function of input	Description	Type X1	Type DI
5	Enable electric heater	Digital input to enable / disable the electric heater via remote control. Enable electric heater is also possible via bus. In this case, the function must not be assigned to any local input X1, D1. See also section 3.6.	DI	DI
6	Fault	Digital input to signal an external fault (example: dirty air filter). If the input is active, "ALx" is displayed and a fault is sent on the bus. See also section 3.10.11. (Alarm x, with x = 1 for X1, x = 3 for D1). <i>Note:</i> Fault displays have no impact on the thermostat's operation. They merely represent a visual signal.	DI	DI
7	Monitor input (Digital)	Digital input to monitor the state of an external switch via bus.	DI	DI
8	Monitor input (Temperature)	Sensor input to monitor the state of an external sensor (e.g. QAH11.1) via bus.	AI	--

- Operational action can be changed between normally open (NO) and normally closed (NC) via parameter P39, P41 (or P43 if it is a digital input)
- Each input X1 or D1 must be configured with a different function (1...5).
Exception: 1 or 2 or 3 inputs can be configured as fault (6) or monitor input (7,8)
- X1 is factory-set to "External sensor" (1) and D1 to "Operating mode switchover" (3)

For more detailed information, refer to section 3.4 "Applications".

Damper position VAV via U1



U1 (0...100%)

The information about the thermostat's damper position can be used to influence the fan speed of a primary air handling unit. The thermostat receives the damper position from a damper actuator or a VAV compact controller as a DC 0...10 V signal using input U1. The damper position (0...100%) is sent on the bus. An RMU7xx primary controller will use the LTE information of all connected room thermostats to calculate the total air flow demand. The state of U1 can be monitored via communication object 38 "U1".

3.9 Handling faults

Temperature out of range

When the room temperature is outside the measuring range, i.e. above 49 °C or below 0 °C, the limiting temperatures blink, e.g. "0 °C" or "49 °C".
In addition, the heating output is activated if the current setpoint is not set to "OFF", the thermostat is in heating mode and the temperature is below 0 °C.
For all other cases, no output is activated.

The thermostat resumes Comfort mode after the temperature returns to within the measuring range.



For fault status messages on the bus, see section 3.10.11.

3.10 KNX communications

The RDG KNX thermostats support communications as per the KNX specification.

S-mode Standard mode; engineering via group addresses.

LTE mode Logical Tag Extended mode, for easy engineering, is used in conjunction with Synco.

3.10.1 S-mode

This mode corresponds to KNX communications.
Connections are established via ETS3 Professional by assigning communication objects to group addresses.

3.10.2 LTE mode

LTE mode was specifically designed to simplify engineering. Unlike with S-mode, there is no need to create the individual connections (group addresses) in the tool. The devices autonomously establish connections.

Definitions

To make this possible, the following circumstances are predefined:

- Every device or subdevice is located within a zone
- Every data point (input or output) is assigned to a zone
- Every data point (input or output) has a precisely defined "name"

Whenever an output and an input with the same "name" are located in the same zone, a connection is established automatically, as shown in the following diagram.

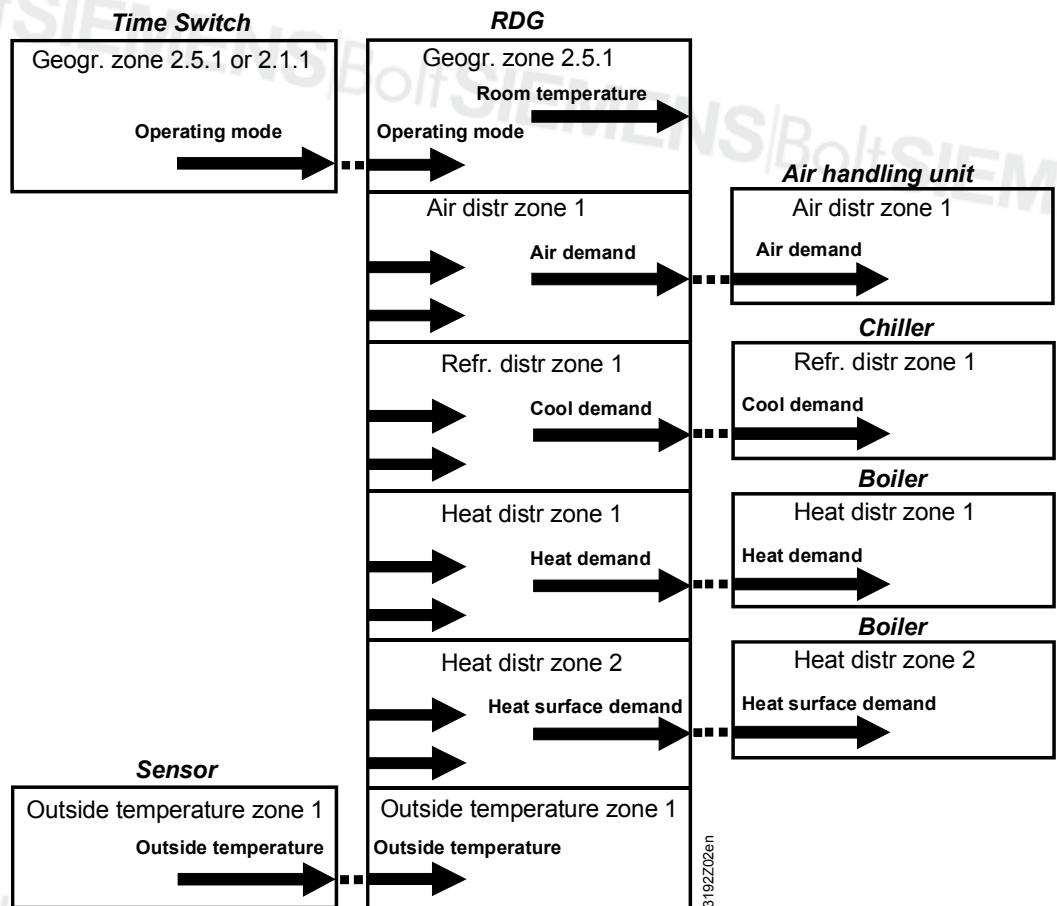

Engineering and commissioning

- For a detailed description of KNX (topology, bus supply, function and setting of LTE zones, filter tables, etc.), see "Communication via the KNX bus for Synco 700, 900 and RXB/RXL, Basic Documentation" [6]
- LTE mode data points and settings are described in the Synco Application Manual [12]
- To engineer and commission a specific system, use the Synco700 planning and commissioning protocol (XLS table in HIT, [7])

3.10.3 Zone addressing in LTE mode (in conjunction with Synco)

In cases where RDG KNX room thermostats are used in LTE mode (e.g. in conjunction with Synco), zone addresses need to be allocated. The following zone address must be defined together with the Synco devices at the planning stage depending on the application.

Short description	Factory setting	Parameter
Geographical zone (apartment)	--- (out of service)	P82
Geographical zone (room)	1	P83
Heat distr zone heating coil	--- (out of service)	P84
Refr distr zone cooling coil	--- (out of service)	P85
Heat distr zone heating surface	--- (out of service)	P86
Air distribution zone	--- (out of service)	P87

Note: "Subzone" of "Geographical zone" is fix 1 (not adjustable)

The device will send and receive LTE communication signals only if the zone address is valid (not OSV = out of service).

The zones to be defined are as follows:

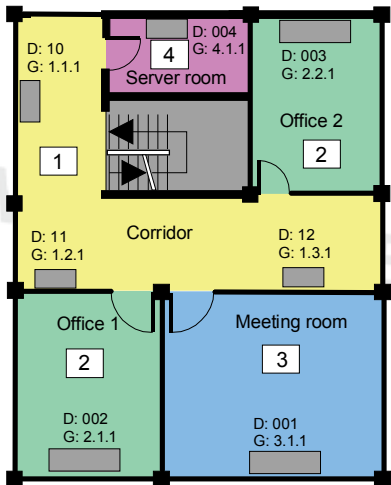
<p>Geographical zone (space zone) (Apartment . Room . Subzone) Apartment = ---, 1...126 Room = ---, 1...63 Subzone = fix 1</p>	<p>Zone in which an RDG KNX thermostat is physically located. Other room-specific devices may also be located in this zone.</p> <p>Information exchanged in this zone is related specifically to the device like operating mode, setpoints, room temperature, etc.</p> <p>The designations "Apartment", "Room" and "Subzone" do not need to be taken literally. For example, Apartment can be used to refer to a group of rooms, floor or section of a building. "Room", however, really does refer to a room.</p> <p>Subzone is not used for HVAC devices. It is more relevant to other disciplines, such as lighting. Subzone is fix at "1" and not visible.</p> <p>The time switch information is expected from the same zone where the thermostat is located (Residential).</p> <p>If no time switch information is received from the same zone, the thermostat will use the information received from the same apartment but with room "1" A.1.1 (Office).</p>
<p>Example: Commercial building In a commercial building, the time switch information is sent by the RMB975 central control unit. The zones are divided in so called "Room groups" (e.g. 1...4), where each "Room group" can have an individual schedule. A room thermostat in the same "Room group" need to have the same Apartment Address.</p> <p>Legend: D = device address (P81) G = geographical zone (P82, P83) (Apartment.Room.Subzone)</p>	 <p>The diagram shows a floor plan with four room groups:</p> <ul style="list-style-type: none"> Room Group 1 (Yellow): Includes a Server room (D: 004, G: 4.1.1), a Corridor (D: 11, G: 1.2.1), and a room (D: 10, G: 1.1.1). Room Group 2 (Green): Includes Office 2 (D: 003, G: 2.2.1) and Office 1 (D: 002, G: 2.1.1). Room Group 3 (Blue): Includes a Meeting room (D: 001, G: 3.1.1) and a room (D: 12, G: 1.3.1). Room Group 4 (Purple): Includes the Server room (D: 004, G: 4.1.1). <p>Legend: D = device address (P81) G = geographical zone (P82, P83) (Apartment.Room.Subzone)</p>
<p>Heat distribution zone heating coil Zone = ---, 1...31</p>	<p>Information related specifically to the hot water system in heating coils is exchanged within this zone. The zone also includes a Synco device to process the information (e.g. RMH7xx or RMU7xx with changeover).</p>
<p>Heat distribution zone heating surface (radiator) Zone = ---, 1...31</p>	<p>Information related specifically to the hot water system of a radiator is exchanged within this zone (e.g. heating demand). This zone also includes a Synco device to process the information (e.g. RMH7xx or RMB7xx).</p>
<p>Refrigeration distribution zone cooling coil Zone = ---, 1...31</p>	<p>Information related specifically to the chilled water system is exchanged within this zone (e.g. cooling demand). This zone also includes a Synco device to process the information (e.g. RMU7xx).</p>

Air distribution zone	This Distribution zone is for air applications (VAV, CAV). Information related specifically to the air handling system is exchanged within this zone (e.g. air demand). This zone also includes a Synco device to process the information (e.g. RMU7xx).
Zone	= ---, 1...31
Outside temperature zone	Outside temperature received in outside temperature zone 1 will be / can be displayed on the room thermostat when commissioned accordingly (parameter P07 = 2).
Zone	= fix 1

3.10.4 Example of heating and cooling demand zone

The building is equipped with Synco controls on the generation side and RDU / RDG thermostats on the room side.

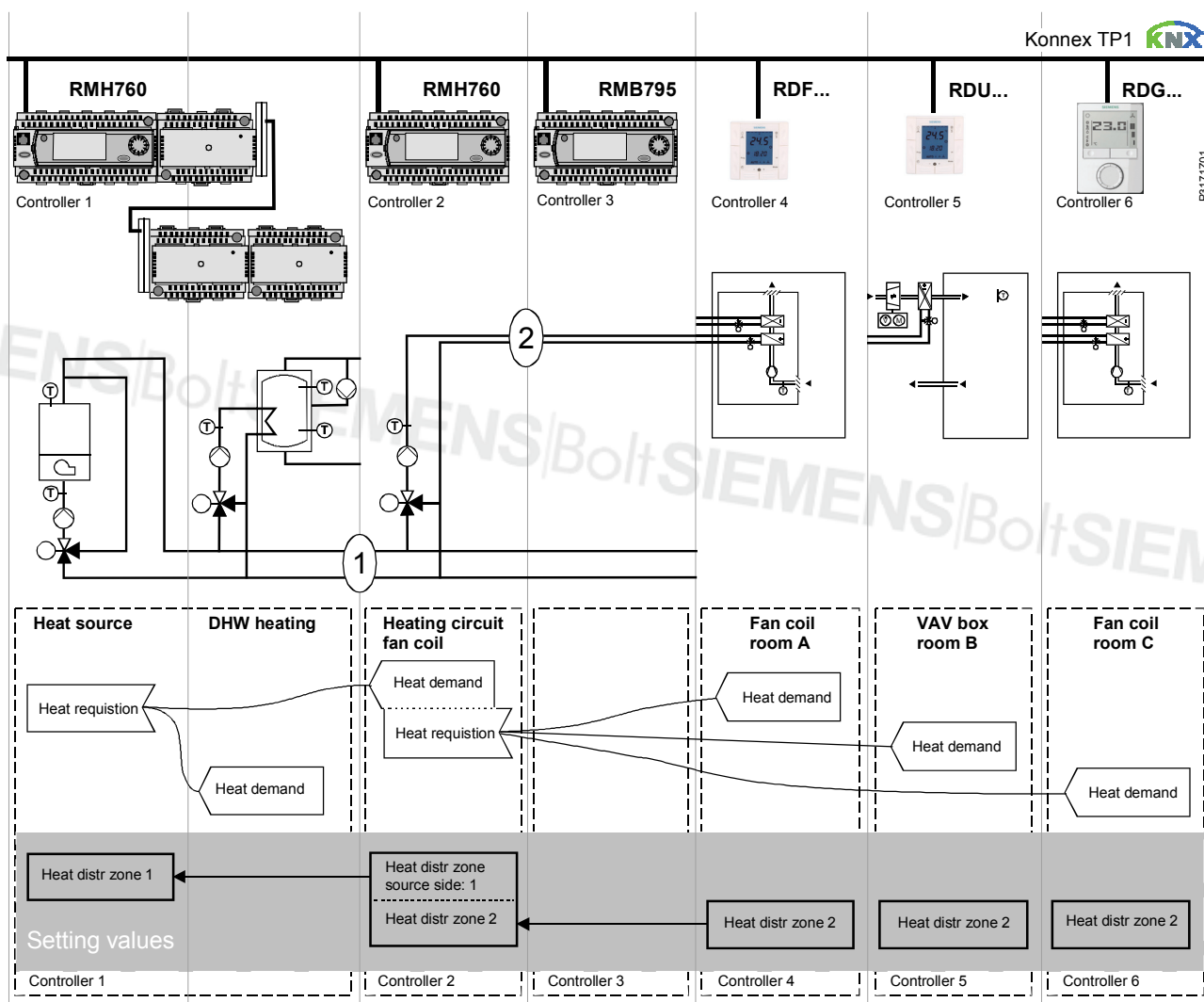

Explanation relating to the illustration

In the case of a typical application, the individual RDU / RDG room thermostats – when used with the RMB975 central control unit – signal their heat demand directly to the primary controller (in the above example to the RMH760).

(1) and (2) designate the numbers of the distribution zone.

- Notes:
- This type of application can analogously be applied to refrigeration distribution zones
 - If no 2-pipe fan coil is used, heat and refrigeration demand signals are sent simultaneously to the primary plant

3.10.5 Send heartbeat and receive timeout

In a KNX network, S-mode and LTE mode communication objects can be exchanged between individual devices. The *Receive timeout* defines the period of time within which all the communication objects requested from a device must have been received at least once. If a communication object is not received within this period, a predefined value is used.

Similarly, the *Send heartbeat* defines the period of time within which all the communication objects requested must be transmitted at least once.

LTE mode / S-mode

Fixed times are specified as follows:

- Receive timeout: 31 minutes
- Send heartbeat: 15 minutes

Reducing the bus load

Individual zones can also be disabled (out of service) via control parameter if they are not being used. In disabled zones, the LTE signal will no longer be periodically sent, and will therefore reduce bus load.

3.10.6 Startup

Startup response

The application is restarted after every reset, so that all the connected motorized valve actuators are synchronized (see "Control outputs", 3.7).

Startup delay

After a reset, it takes up to 5 minutes for all the connected room thermostats to restart. This is designed to avoid overloading the network when restarting. At the same time, it reduces the load on the KNX network, as not all thermostats transmit data at the same time. The delay ($T_{\text{WaitDevice}}$) is determined by the thermostat's device address. After the delay, the device starts to send.

3.10.7 Heating and cooling demand

In conjunction with Synco, the heating and/or cooling demand (for water) from each room is transmitted to the BACS to provide the required heating or cooling energy.

An example for LTE mode is described in section 3.10.4.

In S-mode, the current state signals of the control outputs are available.



Heating output primary
Cooling output primary

3.10.8 Air demand

In conjunction with Synco, the air demand from each room is transmitted to the BACS to provide the required air volume.

In S-mode, the current state signal of the damper is available.



Control output VAV

3.10.9 Electric heater interlock by supply air controller (LTE mode only)

To avoid overheating of an electric heater, sufficient flow of supply air must be guaranteed. The thermostat features the function "Interlock of el. heater via supply air controller", which is active when a supply air controller (e.g. Synco RMU7xx) is used in the system. The supply fan controller sends the fan status (StatusSATC) to the thermostat when the supply fan is running, after which the el heater is allowed to turn on if there is a call for heat.

When the supply fan is not running, then the el. heater keeps turned off, even though there is a demand for heat.

The fan symbol  is displayed, when the supply fan is on.

- Notes
- Electric heater enable via local input X1 / D1 or via KNX will override any release by this interlock function and vice versa (last intervention wins).
 - After power-up of the thermostat the electric heater is completely disabled for at least 5 minutes or until a supply air controller is detected. If no supply fan controller is in the system, the el. heater is allowed to turn on if there is a demand for heat.
 - The fan information is broadcast every 15 minutes or on change of value. If no value is received any more, the thermostat will disable the interlock function after a timeout of 31 minutes.

Caution 

General rule: In case of insufficient air flow, the thermostat cannot protect the electrical heater against overtemperature. Therefore the electric heater MUST feature a separate safety device (thermal cutout).

3.10.10 Primary fan overrun after switching off the electric heater

To avoid overheating of an electric heater after it has been switched off, the air flow must be maintained for a while.

In conjunction with a supply air controller (e.g. Synco RMU7xx) this will be automatically assured by exchanging the necessary information. The supply fan controller will only switch off the supply fan once all el. heaters are cooled off.

Note: The cool off time of the el. heater can be adjusted for each el. heater via parameter "fan overrun time" (P54, factory setting 60sec).

Caution 

General rule: In case of insufficient air flow, the thermostat cannot protect the electrical heater against overtemperature. Therefore the electric heater MUST feature a separate safety device (thermal cutout).

3.10.11 Fault function on KNX

If a fault occurs (e.g. digital fault input, dew point, communication configuration, etc.) then a fault will be sent on the bus.

An RDG thermostat listens on the bus and sends its fault when the fault has the highest alarm priority. This ensures that the management station does not miss any alarms.

If alarms occur at the same time, the alarm with the highest priority will be first displayed and sent on the bus.



Fault transmission is different in LTE mode and S-mode:

S-mode	LTE mode
Fault state	Alarm info (error code + internal information)
Fault information (internal information)	Alarm text (default text can be edited with ACS700 tool)

The table below shows the error code and default alarm texts.

Prio	Fault	Thermostat	Fault information on bus		
		Display	Error code	Default fault text	Text adjustable *)
-	No fault	---	0	No fault	✓
1	Bus power supply**)	🔔 bus	5000	No bus power supply	---
2	Device address error	🔔 Addr	6001	>1 id device address	---
3	Condensation	🔔 💧	4930	Condensation in the room	✓
4	External fault input X1	🔔 AL1	9001	Fault input 1	✓
5	External fault input D1	🔔 AL3	9003	Fault input 3	✓

*) Default alarm texts are stored in the thermostat's non-volatile memory and can be adjusted using the ACS700 commissioning tool

**) This error will not be sent on bus (because there is no bus!)

Priority of alarms

- Priority order is #1...5
- External faults #4...5: If faults are active, the display will show AL1, AL3, alternating. On the bus, only the fault with the highest priority will be sent



Fault transmission

A supervisor alarm system may command the thermostat to stop sending faults to the bus via the communication object "Fault transmission" (disable / enable). This has no impact on the local display of faults.

After a timeout of 48 hours, the sending of faults will automatically be enabled again.

3.10.12 Emergency control (LTE Mode only)

In case of smoke or fire the damper can be overridden via KNX.

The necessary information is provided by the function block "HVAC Emergency Mode"

The table below describes the behavior of the controller output.

#	Datapoint value	Damper
0	Normal	Normal operation
1	EmergPressure	Fully open
2	EmergDepressure	Fully closed
3	EmergPurge	Fully open
4	EmergShutdown	Fully closed
5	EmergFire	Fully closed

Emergency signals have highest priority and command the control output accordingly. Any ongoing function like fan-overrun etc. will be stopped immediately.

The priority is as follows:

1. Smoke (Emergency 1..4)
2. Fire (Emergency 5)
3. Fan overrun (Emergency 0 and el heater fan overrun function is active)
4. Normal operation (Emergency 0 and operation by operating mode button)

3.11 Communication objects (S-mode)

3.11.1 Overview

Page	Object # and name	Thermostat	Object # and name	Page
13	1 System time	→		
13	3 Time of day	→		
13	38 Outside temperature	→	→ 21 Room temperature	13
15	12 Room operating mode: Time switch ¹⁾	→	→ 16 Room operating mode: State ¹⁾	14
15	7 Room operating mode: Preselection ¹⁾	↔	→ 24 Room temperature: Current setpoint	23
14, 16, 44	20 Room operating mode: Window state	→	→ 25 Control output VAV	50
22	22 Room temperature: Comfort basic setpoint	→	→ 26 Heating output primary ²⁾	50
22	23 Room temperature: Comfort setpoint	↔	→ 27 Cooling output primary ²⁾	50
29	31 Application mode	→	→ 37 D1	45
45	28 Enable electric heater	→	→ 32/33 X1 (temperature / digital)	45
25, 44	30 Supply air temperature	→	→ 36 U1 (0...100%)	45
44	29 Heating / cooling ch'over ²⁾	→		
52	6 Fault transmission	→	→ 5 Fault state	27, 52
			→ 4 Fault information	27, 45, 52



Input communication object



Output communication object



Input & output communication object

1) 8-bit and 1-bit object available, selectable via parameter in ETS3

2) Availability depending on selected application / function

3.11.2 Description of communication objects

Obj	Object name	Function	Type/ length	Flags
1	System time	Time and date	19.001 8 Byte	CWU
System time for display on the room thermostat. See parameter P07 (3 or 4)				
3	Time of day	Time and date	10.001 3 Byte	CWU
Another object for receiving the time of day for display on the room thermostat. See parameter P07 (3 or 4)				
4	Fault information	Alarm Info	219.001 6 Byte	CT
Common alarm output. If an alarm occurs, the alarm number is transmitted				
5	Fault state	Faulty / normal	1.005 1 bit	CT
Common alarm output. If an alarm occurs, the alarm flag is set				
6	Fault transmission	Enable / disable	1.003 1 bit	CWU
A supervisor alarm system can disable the broadcasting of alarms by the devices. This has no impact on the local display of alarms. After a timeout of 48 hours, the sending of faults will automatically be enabled again.				
7	Room operating mode: Preselection	Auto Comfort PreComf. Economy Protection	20.102 1 Byte	CWTU
Controls the room operating mode selection of the thermostat via bus. The command can also be submitted as four 1-bit communication objects (8...11). The last interaction wins – either from local operating mode button or via bus. Note: The thermostat will transform Precomfort either into Economy or Comfort (selectable via P88).				
8	Operating mode: Preselection Auto Comf Eco Prot	Trigger	1.017 1 bit	CW
9				
10				
11				
Switch room operating mode to either Auto, Comfort, Economy or Protection. The last interaction wins – either from the local operating mode button or via bus.				
12	Room operating mode: Time switch	Comfort Economy PreComf. Protection	20.102 1 Byte	CWU
This information is provided by a central time switch or a supervisor and defines the actual HVAC operating mode. The command can also be submitted via three 1-bit communication objects (13...15). Protection has the highest priority and cannot be overridden. Note: The thermostat will transform Precomfort either into Economy or Comfort (selectable P88).				
13	Time switch Comfort Economy Protection	Trigger	1.017 1 bit	CW
14				
15				
Switch the HVAC mode to either Comfort, Economy or Protection mode.				

Obj	Object name	Function	Type/ length	Flags
16	Room operating mode: State	Comfort Economy Protection	20.102 1 Byte	CRT
Effective room operating mode used by the thermostat (considering time switch, user selection, window contact, etc.) This state information is available via one 8-bit enumeration or three 1-bit communication objects (17...19). Note: The thermostat does not support Precomfort.				
17	Room operating mode: State State Comfort State Economy State Protection	ON	1.002 1 bit	CT
18		OFF		
19				
Corresponding communication object sends "True"				
20	Window state	Open Closed	1.019 1 bit	CWU
The thermostat is set to Economy mode if value "1" (open) is received. It switches back to the previous mode when the value is "0" (closed). "Window state" is sent e.g. by a KNX switch or a KNX presence detector. It has the same effect as the local operating mode switchover contact X1, D1 (parameter P38, P42). <i>Only one input source must be used, either local input X1/ D1 or KNX bus.</i>				
21	Room temperature	Temp. value	9.001 2 Bytes	CRT
The value of the room temperature measured via built-in or external sensor is available via this communication object.				
22	Room temperature: Comfort basic setpoint	Temp. value	9.001 2 Bytes	CWU
If function "Temporary setpoint" is enabled via parameter P69, then after an operating mode change, the setpoint adjustments made by the user and via communication object 23 will be dismissed and the thermostat will be reset to the Comfort basic setpoint. Note: Setpoints that have been changed via the local HMI may be overwritten during a system startup from a central master controller, e.g. RMB795. <i>The Comfort basic setpoint is stored in EEPROM (see section 3.3.2). → The service life of the EEPROM depends on the number of write cycles. Never write this communication object cyclically!</i>				
23	Room temperature: Comfort setpoint	Temp. value	9.001 2 Bytes	CWTU
Communication object used to shift the setpoint used by the thermostat (see section 3.3.2). Same priority as local setpoint shift on the thermostat. The last intervention wins. Note: The Comfort basic setpoint (object 22) will not be changed.				
24	Room temperature: Current setpoint	Temp. value	9.001 2 Bytes	CRT
Current setpoint, including shift, compensation, etc., used by the thermostat for temperature control				
25	Control output VAV	0...100%	5.001 8 bit	CRT
Indicates the position of the air damper. E.g. single duct				
26	Heating output primary	0...100%	5.001 8 bit	CRT
Indicates the position of the heating actuator of the auxiliary heating. E.g. single duct with electric heater application: Output of the electric heater.				

Obj	Object name	Function	Type/ length	Flags
27	Cooling output primary	0...100%	5.001 8 bit	CRT
Indicates the position of the cooling actuator of the first stage. E.g. single duct with h/c coil application: Output of the cooling coil				
28	Enable electric heater	Enable / disable	1.003 1 bit	CWU
An electric heater can be disabled with this communication object (e.g. to meet tariff regulations). The same function is also available via local multifunctional input X1/ D1 (parameter P38, P42). <i>Only one input source must be used, either local input X1 /D1 or KNX bus.</i>				
29	Heating / cooling changeover	Heat / Cool	1.100 1 bit	CWU
Changeover information transmitted via bus. Only available with application "Single duct with heating / cooling coil". Default: Current mode before power down. The same function is also available via local multifunctional input X1/ D1 (parameter P38, P42). <i>Only one input source must be used, either local input X1/X2/D1 or KNX bus.</i>				
30	Supply air temperature	Temp. value	9.001 2 Byte	CWU
The supply air temperature sent by the supply air controller indicates whether cold or hot air is supplied (for VAV changeover). The controller determines the necessity to open or close the air damper according to the supply air temperature, the room temperature setpoint, and the current room temperature. The same function is also available via local multifunctional input X1/ D1 (parameter P38, P42). <i>Only one input source must be used, either local input X1/X2/D1 or KNX bus.</i>				

Obj	Object name	Function	Type/ length	Flags
31	Application mode	HVAC control mode	20.105 8 bit	CWU
0	Auto (default)	Heating and/or cooling		
1	Heat	Heating only		
2	Morning warmup*	Heating only		
3	Cool	Cooling only		
4	Night purge	Open damper fully		
5	Precool*	Cooling only		
6	OFF	Neither heating nor cooling		
8	Emergency heat*	Heating only		
9	Fan only	Open damper fully (= night purge)		
* Function handled like Heat (1) or Cool (3)				
32	X1: Temperature	Temp. value	9.001 2 Byte	CRT
Indicates the values of the temperature sensors connected to the local inputs X1 / X2				
33	X1: Digital	ON	1.001	CRT
37	D1: Digital	OFF	1 bit	CRT
Indicate the status of the digital inputs (adjusted by parameters P39 /P43) including considering of operating action				
36	U1: 0..10V	0...100%	5.001 8 bit	CRT
Voltage DC 0...10 V at input U1 is indicated as a value 0...100%				
38	Outside temperature	Temp. value	9.001 2 Byte	CWU
The outside temperature measured by a KNX sensor can be displayed on the thermostat, if parameter P07 "Additional user information" is set = 2 (outside temperature).				

3.12 Control parameters

A number of control parameters can be readjusted to optimize control performance. This can be done on the thermostat via HMI or via commissioning / operating tool. These parameters can also be set during operation without opening the unit. In the event of a power failure, all control parameter settings are retained.

The control parameters are assigned to 2 levels:

- “Service level”, and
- “Expert level” including communications, diagnostics and test

The “Service level” contains a small set of parameters to set up the thermostat for the HVAC system and to adjust the user interface. These parameters can be adjusted any time.

Change parameters at the “Expert level” carefully, as they impact the thermostat’s control performance and functionality.

3.12.1 Parameter setting via local HMI

Enter only “Service level”

1. Press left and right button simultaneously for >3 seconds, release them, then press the right button for >3 seconds.
The display shows “P01”.
Continue with step 2.

Enter “Expert level” and “Diagnostics & test”

1. Press left button and right button simultaneously for >3 seconds, release them, press the left button for >3 seconds, then turn the rotary knob counterclockwise min. ½ rotation.
The display shows “Pxx”.
Continue with step 2.

Adjust parameters

2. Select the required parameter by turning the rotary knob.
3. Press button ✓ (OK); the current value of the selected parameter starts blinking and can be changed by turning the rotary knob.
4. Press button ✓ (OK) to confirm the adjusted value or press button ↵ (Esc) to cancel the change.
5. If you wish to adjust additional parameters, repeat steps 2...4.
6. Press button ↵ (Esc) to leave the parameter setting mode.

Reset parameters

The factory setting for the control parameters can be reloaded via parameter P71, by changing the value to “ON”. Confirm by pressing the right button. The display shows “8888” during reloading.

3.12.2 Parameter setting / download via tool

Control parameters can be adjusted via bus either by parameter download during commissioning or during normal operation with a tool like ACS700.

With the ACS700 tool, the parameters can be changed...



ACS Service

– during commissioning via parameter download (all parameters)



ACS Operating

– during normal operation via Popcard (most of the parameters)

**OZW772 Web server,
RMZ792 bus operator
unit**

Most parameters can be changed during normal operation using the OZW772 web server or the RMZ792 bus operator unit.



ETS3 Professional

Only the parameters for device address can be downloaded via ETS3 Professional. This is to simplify and avoid a conflict.

It allows you to further engineer communication objects of an RDG previously commissioned via local HMI or ACS (assigning communication objects to group addresses).

Notes:

- The basic application can only be changed via parameter download with ACS.
- The RDG KNX thermostats require version ETS3f or higher / ACS700 version 5.11 or higher.

Connecting a KNX tool

Connecting a KNX commissioning / operating tool to the RDG is described in section 4.2.

3.12.3 Parameters of the "Service level"

Parameter	Name	Factory setting	Range
Service level			
P01	Control sequence	1 = Cooling only	0 = Heating only 1 = Cooling only 2 = H/C changeover manual 3 = H/C changeover auto
P02	Operation via room op selector	1	1 = Auto - Protection 2 = Auto - Comfort - Economy - Protection
P04	Unit	C (0)	C = ° Celsius F = ° Fahrenheit
P05	Measured value correction	0 K	- 3 ... 3 K
P06	Standard display	0	0 = Room temperature 1 = Setpoint
P07	Additional display information	0	0 = --- (No display) 1 = °C and °F 2 = Outside temperature (via bus) 3 = Time of day (12h) (via bus) 4 = Time of day (24h) (via bus)
P08	Comfort basic setpoint	21 °C	5 ... 40 °C
P09	Comfort setpoint minimum	5 °C	5 ... 40 °C
P10	Comfort setpoint maximum	35 °C	5 ... 40 °C
P11	Economy heating setpoint	15 °C	OFF, 5 ... WCoolEco; WCoolEco = 40 °C max
P12	Economy cooling setpoint	30 °C	OFF, WHeatEco ... 40 °C; WHeatEco = 5C min
P14	Button lock	0	0 = Unlocked 1 = Auto lock 2 = Manual lock

Note: Parameter display depends on selected application and function.





3.12.4 Parameters of the "Expert level with diagnostics and test"

Parameter	Name	Factory setting	Range
	Expert level		
P30	Heat P-band Xp / switching diff	2 K	0.5 ... 6 K
P31	Cool P-band Xp / switching diff	1 K	0.5 ... 6 K
P32	Radiator P-band Xp / swi diff	2 K	0.5 ... 6 K
P33	Dead zone Comfort mode	2 K	0.5 ... 5 K
P35	Integral action time Tn	5 min	0...10 min
P36	H/C ch'over swi point cooling	16 °C	10...25 °C
P37	H/C ch'over swi point heating	28 °C	27...40 °C
P38	Input X1	1: = Ext. sensor	0 = --- (no function) 1 = Room temp ext. sensor / Return air temp (AI) 2 = H/C changeover (AI/DI) 3 = Operating mode contact (DI) 4 = Dew point sensor (DI) 5 = Enable electric heater (DI) 6 = Fault input (DI) 7 = Monitor input (Digital) 8 = Monitor input (Temp)
P39	Normal position input X1	0 (N.O.)	0 = Normally open / Open 1 = Normally closed / Close
P42	Input D1	3 = Op mode contact	0 = --- (no function) 2 = H/C changeover (DI) 3 = Operating mode contact (DI) 4 = Dew point sensor (DI) 5 = Enable electric heater (DI) 6 = Fault input (DI) 7 = Monitor input (Digital)
P43	Normal position input D1	0 (N.O.)	0 = Normally open / Open 1 = Normally closed / Close
P44	Actuator running time Y1/Y2	150 s	20...300 sec
P46	Output Y1/Y2	ON/OFF (1)	0 = 3-position 1 = 2-position 2 = PWM
P47	Controller output VAV	0 = 0...10V	0 = 0...10V 1 = 3-position
P51	Flow temp limit floor heating	OFF	OFF, 10...50 °C
P63	Supply air limit value min	0%	0...P64 (%)
P64	Supply air limit value max	100%	P63...100 (%)
P65	Protection heating setpoint	8 °C	OFF, 5...WCoolProt; WCoolProt = 40 °C max
P66	Protection cooling setpoint	OFF	OFF, WHeatProt... 40; WHeatProt = 5°C min
P68	Temporary Comfort mode	0 (= OFF)	0...360 min
P69	Temporary Comfort setpoint	OFF	OFF = Disabled ON = Enabled
P71	Restore factory setting	OFF	OFF = Disabled ON = Reload start "8888" is displayed for 3s during reload process

Parameter	Name	Factory setting	Range
Communications			
P81	Device address 1)	255	1...255
P82	Geographical zone (apartment) 2)	---	---, 1...126
P83	Geographical zone (room) 2)	1	---, 1...63
P84	Heat distr zone heating coil	---	---, 1...31
P85	Refrig distr zone cooling coil	---	---, 1...31
P86	Heat distr zone heating surface	---	---, 1...31
P87	Air distribution zone	---	---, 1...31
P88	Transformation Precomfort	0	0 = Economy 1 = Comfort

Note: P46, P47: Setting to 2-position or 3-position is made with DIP switches 4 and 5

- 1) Physical address = Area.Line.DeviceAddress. Factory setting for Area = 0, Line = 2.
Can be changed by special management service e.g. from line coupler or via ACS commissioning tool.
- 2) Type = geographical zone A.R.S. In RDG sub zone = fixed value 1

Parameter	Name	Range
Diagnostics & test		
d01	Application number	0 = --- (No application) 1 = Single duct 2 = Single duct with electric heater 3 = Single duct with radiator 4 = Single duct with H/C coil
d02	X1 state	0 = Not activated (for DI) 1 = Activated (DI) 0...49 °C = Current temp. value (for AI) 00  = H/C Input shorted 100  = H/C Input open
d04	D1 state	0 = Not activated (for DI) 1 = Activated (DI) 00  = H/C Input shorted 100  = H/C Input open
d05	Test mode for checking the Y1/Y2 actuator's running direction 3)	"---" = no signal on outputs Y1 and Y2 OPE = output Y1 forced opening CLO = output Y2 forced closing
d07	Software version	Ux.xx is displayed

- 3) This parameter can only be quit when the setting is back at "---".
Press the left button to escape.

4. Handling

4.1 Mounting and installation

Do not mount on a wall in niches or bookshelves, behind curtains, above or near heat sources, or exposed to direct solar radiation. Mount about 1.5 m above the floor.

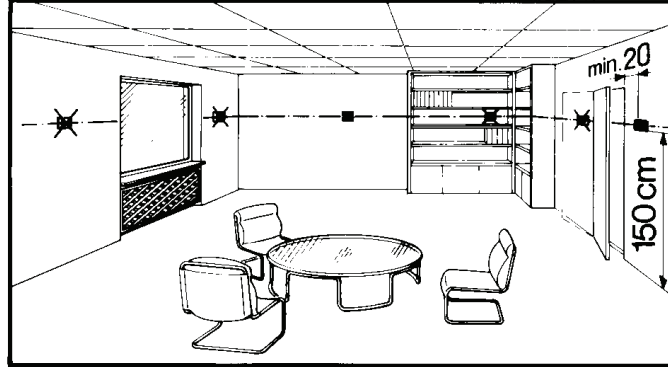

Mounting



- Mount the room thermostat in a clean, dry indoor place without direct airflow from a heating / cooling device, and not exposed to dripping or splash water

Wiring



See Mounting Instructions M3192 [3] enclosed with the thermostat.

- Comply with local regulations to wire, fuse and earth the thermostat.
- The power supply line must have an external fuse or circuit breaker with a rated current of no more than 10 A.
- Isolate the cables of inputs X1-M, U1-G0 and D1-GND for 230 V if the conduit box carries AC 230 V mains voltage.
- Inputs X1-M or D1-GND: Several switches (e.g. summer/winter switch) may be connected in parallel. Consider overall maximum contact sensing current for switch rating.
- Isolate the cables of KNX communication input CE+ / CE- for 230 V if the conduit box carries AC 230 V mains voltage.
- No cables provided with a metal sheath.
- Disconnect from supply before removing from the mounting plate.

4.2 Commissioning

Applications

The room thermostats are delivered with a fixed set of applications.

Select and activate the relevant application during commissioning using one of the following tools:

- Local DIP switch and HMI
- Synco ACS
- ETS3 Professional
(Parameter and application download with ETS3 will be implemented later)

DIP switches

Set the DIP switches before snapping the thermostat to the mounting plate, if you want to select an application via **DIP switches**.

All DIP switches need to be set to “OFF” (remote configuration), if you want to select an application via **commissioning tool**.

After power is applied, the thermostat resets and all LCD segments flash, indicating that the reset was correct. After the reset, which takes about 3 seconds, the thermostat is ready for commissioning by qualified HVAC staff.

If all DIP switches are OFF, the display reads "NO APPL" to indicate that application commissioning via a tool is required.

Note: Each time the application is changed, the thermostat reloads the factory setting for all control parameters, except for KNX device and zone addresses!

Connect tool

Connect the Synco ACS or ETS3 Professional tools to the KNX bus cable at any point for commissioning:

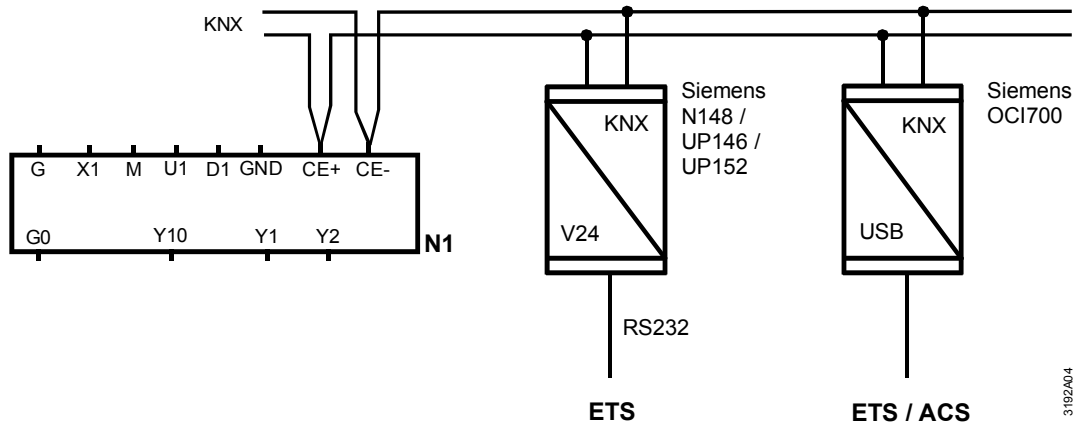

ACS and ETS3 require an interface:

- RS232 KNX interface (e.g. Siemens N148 / UP146 / UP152)
- OCI700.1 USB-KNX interface

Note: An external KNX bus power supply is required if an RDG is connected directly to a tool (ACS700 or ETS3) via KNX interface.

Control parameters

The thermostat's control parameters can be set to ensure optimum performance of the entire system.

The parameters can be adjusted using

- Local HMI
- Synco ACS
- ETS3 Professional

Parameter and application *download* with ETS3 will be implemented later.

The control parameters of the thermostat can be set to ensure optimum performance of the entire system (see section 3.11, control parameters).

Control sequence

- The control sequence may need to be set via parameter P01 depending on the application. The factory setting is as follows:

Application	Factory setting P01
Single duct, Single duct with H/C coil	1 = cooling only
Single duct with el. heater, Single duct with radiator	Not adjustable

Calibrate sensor	<ul style="list-style-type: none"> Recalibrate the temperature sensor if the room temperature displayed on the thermostat does not match the room temperature measured (after min. 1 hour of operation). To do this, change parameter P05
Setpoint and range limitation	<ul style="list-style-type: none"> We recommend to review the setpoints and setpoint ranges (parameters P08...P12) and change them as needed to achieve maximum comfort and save energy
Programming mode	<p>The programming mode helps identify the thermostat in the KNX network during commissioning.</p> <p>Press left and right buttons simultaneously for 6 seconds to activate programming mode, which is indicated on the display with "PrOG".</p> <p>Programming mode remains active until thermostat identification is complete.</p>
Assign KNX group addresses	<p>Use ETS3 Professional to assign the KNX group addresses of the thermostat's communication objects.</p>
KNX serial number	<p>Each device has a unique KNX serial number at the rear.</p> <p>An additional sticker with the same KNX serial number is enclosed in the packaging box. This sticker is intended for installers for documentation purposes.</p>

4.3 Operation

See also Operating Instructions B3192 [2] enclosed with the thermostat.

Layout

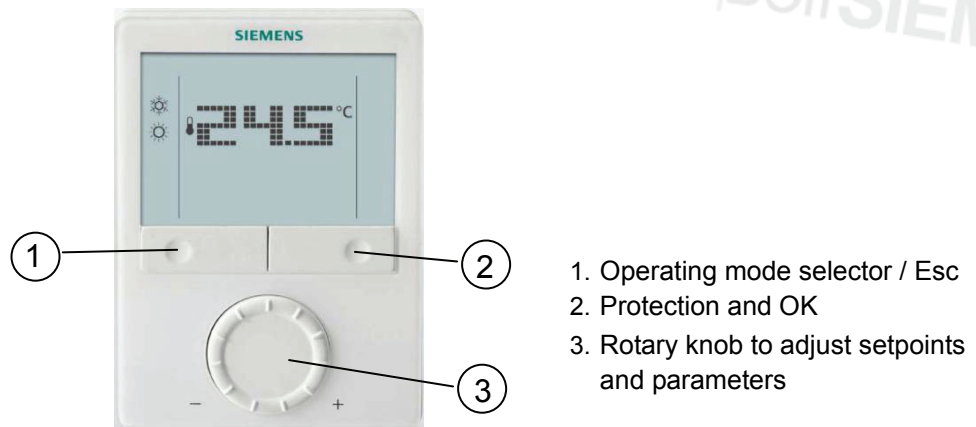

Button operation

User action	Effect, description
Normal operation	Actual operating mode and state are indicated by symbols
Press any button (thermostat in normal operation)	Enter operating mode selection; backlit LCD turns on, all possible mode symbols turn on, indicator element (arrow) will appear on the current mode / state
Press left button	Change operating mode (indicator element (arrow) changes to the next mode symbol. After the last press and a timeout of 3 seconds, the newly selected mode is confirmed, the other elements disappear. After a timeout of 20 seconds, the LCD backlight turns off
Press left button (P01 = 2)	Toggle between heating and cooling
Press left button while "Operating mode" via bus is Economy or while operating mode switchover contact is activated	Activate "Extend Comfort mode" (for details, see page 17)
Keep left button depressed and turn rotary knob clockwise / counterclockwise	Activate timer "Extend presence" / "Extend absence" and set the time (for details, see page 17)
Press right button >3 seconds	Activate / deactivate button lock
Press right button	Set thermostat to Protection mode or back to previous operation mode
Turn rotary knob	Adjust the room temperature Comfort setpoint
Press left and right button >3 seconds, release, then press right button >3 seconds	Enter parameter setting mode "Service level"
Press left and right button for 3 seconds, release, press left button for 3 seconds, then turn rotary knob counterclockwise min. 1/2 revolution	Enter parameter setting mode "Expert level", diagnostics and test
Press left and right button simultaneously for 6 seconds	Enter (KNX) programming mode

Display

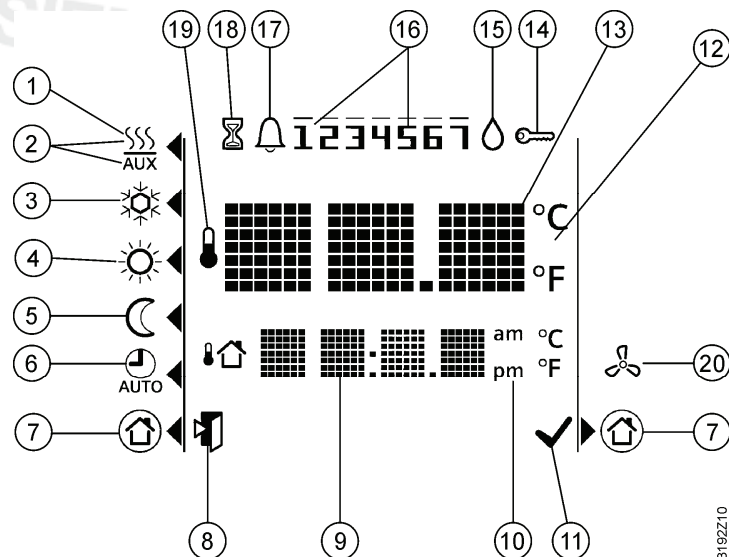

#	Symbol	Description	#	Symbol	Description
1		Heating mode	11		Confirmation of parameters
2		Heating mode, electric heater active	12		Degrees Celsius Degrees Fahrenheit
3		Cooling mode	13		Digits for room temperature and setpoint display
4		Comfort	14		Button lock active
5		Economy	15		Condensation in room (dewpoint sensor active)
6		Auto Timer mode according to schedule (via KNX)	16		Weekday 1...7 from KNX bus 1 = Monday / 7 = Sunday
7		Protection mode	17		Fault
8		Escape	18		Temporary timer function; visible when operating mode is temporarily extended (extended presence or absence)
9		Additional user information, like outdoor temperature or time of day from KNX bus. Selectable via parameters	19		Indicates that room temperature is displayed
10		Morning: 12-hour format Afternoon: 12-hour format	20		Primary fan is active (only supported with Synco700 primary controller)

4.4 Remote operation

The RDU thermostats can be operated from a remote location using a OZW772 / OZW775 web server, a RMZ792 bus operating unit or the ACS Operating tool.

4.5 Disposal



The device is classified as waste electronic equipment in terms of the European Directive 2002/96/EC (WEEE) and should not be disposed of as unsorted municipal waste.

The relevant national legal rules must be adhered to.

Regarding disposal, use the systems setup for collecting electronic waste.

Observe all local and applicable laws.

5. Supported KNX tools

5.1 ETS3 Professional



ETS3 Professional

ETS3 Professional is an engineering tool. It is used to set up the communication of the RDG KNX thermostat and assigns the communication object to group addresses (S-mode).

Parameters are only used for choosing (making visible / hiding) the communication objects.

This Manual does not describe how to operate ETS3 Professional and commission a device. Refer to the KNX Manual for more details.



Note!

Setting RDG KNX parameters is only supported by ETS3f or higher.

5.1.1 Parameter settings in ETS Professional

For setting the parameters, open the project and select a device. To start the parameter settings, select **Edit**, then **Edit parameters**.

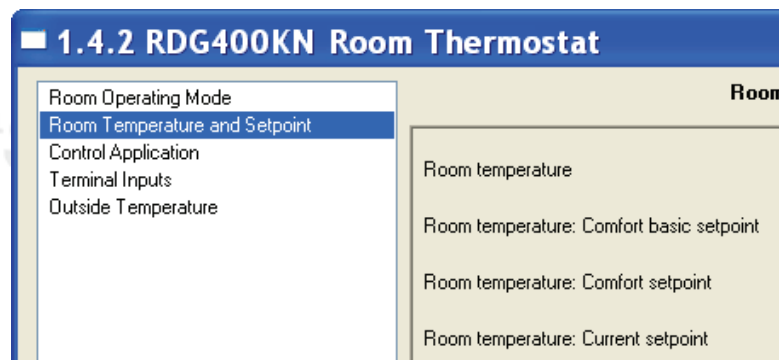

- Notes:
- Parameters are only used to choose the communication objects
 - The tool required is ETS3 Professional version 3f or higher!

5.2 ACS700 Service and Operating tool



ACS Service

ACS Operating

With the ACS700 tools, the RDG KNX thermostats can be commissioned (physical address, application, parameters). They can be operated or monitored via bus during normal operation.

This Manual does not describe how the physical address is defined. Also, it only gives a brief overview of the main functionality of ACS.

For more information, refer to the ACS online help.



Note!

Setting RDG KNX parameters is only supported by ACS700 Version 5.11 or higher.

5.2.1 Parameter settings in ACS

In the **ACS Service** program, select **Plant**, then **Open** to open the plant.

To start the parameter settings, select **Applications**, then **Parameter settings...**:

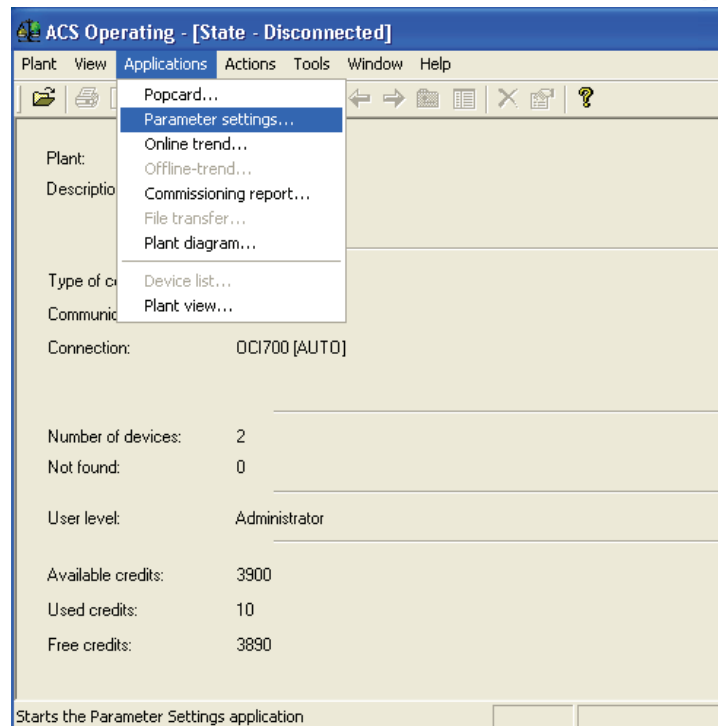

The **application and control parameters** can be adjusted and downloaded.

Column *Line no.* contains the parameter number as shown in the parameter table.

Refer to section 3.11, control parameters.

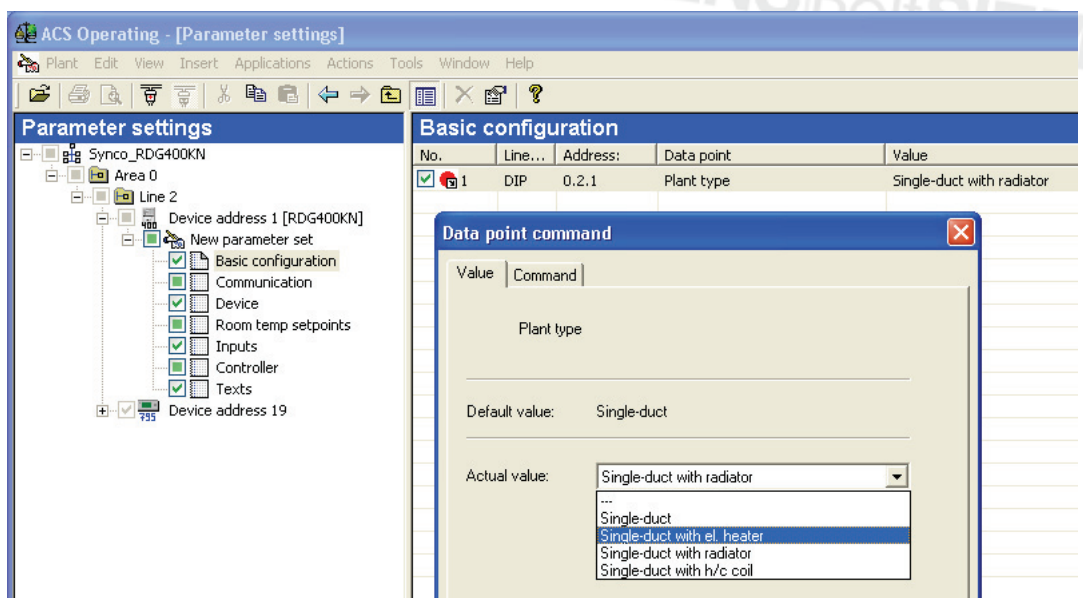

5.2.2 Operation and monitoring with ACS

ACS Operating

In the **ACS Operating** program, select **Plant**, then **Open** to open the plant.
To start monitoring and operation, select **Applications**, then **Popcard**

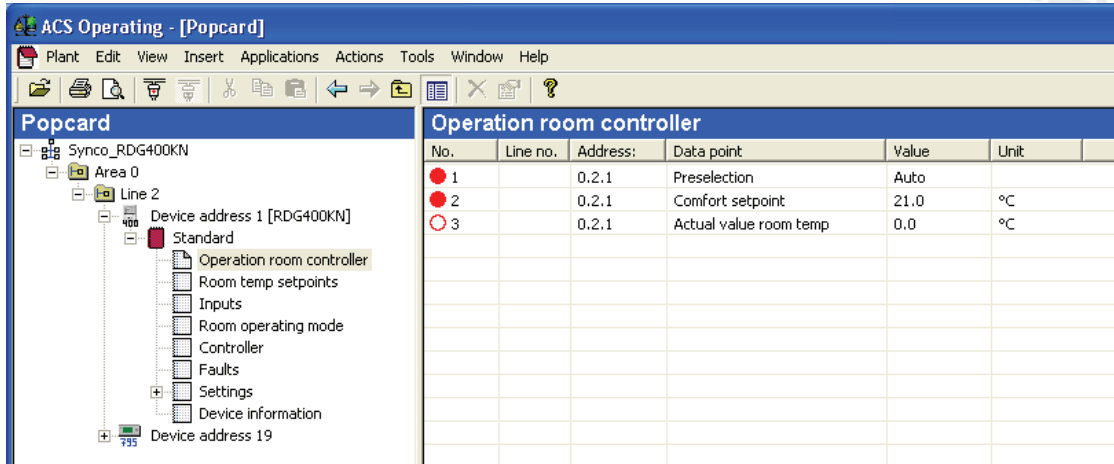

No.	Line no.	Address:	Data point	Value	Unit
1		0.2.1	Preselection	Auto	
2		0.2.1	Comfort setpoint	21.0	°C
3		0.2.1	Actual value room temp	0.0	°C

Parameter settings in ACS Operating

ACS Operating supports parameter settings even during normal operation.

To change a control parameter, select **Popcard**, then **Settings**.

- Notes:
- Make sure you have logged on with sufficient access right
 - Only control parameter can be changed, no application!

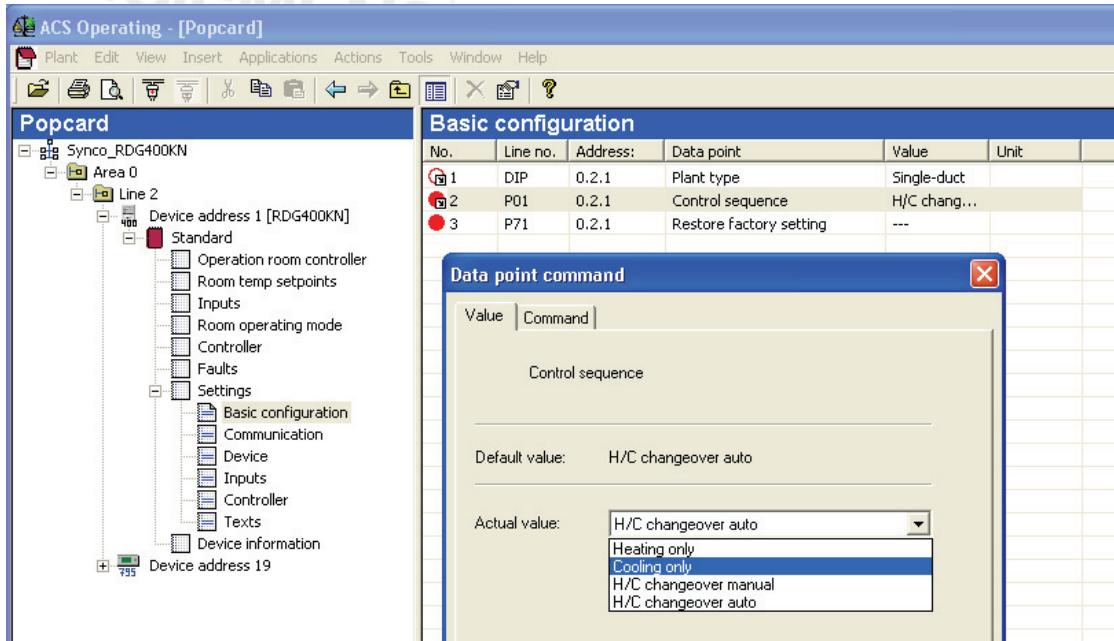

No.	Line no.	Address:	Data point	Value	Unit
1	DIP	0.2.1	Plant type	Single-duct	
2	P01	0.2.1	Control sequence	H/C chang...	
3	P71	0.2.1	Restore factory setting	---	

Data point command

Value | Command

Control sequence

Default value: H/C changeover auto

Actual value:

- Heating only
- Cooling only
- H/C changeover manual
- H/C changeover auto

Plant diagram in ACS Operating

ACS Operating offers plant diagrams for easy monitoring and operation of the thermostat.

To start this application, select **Applications**, then **Pant diagram**

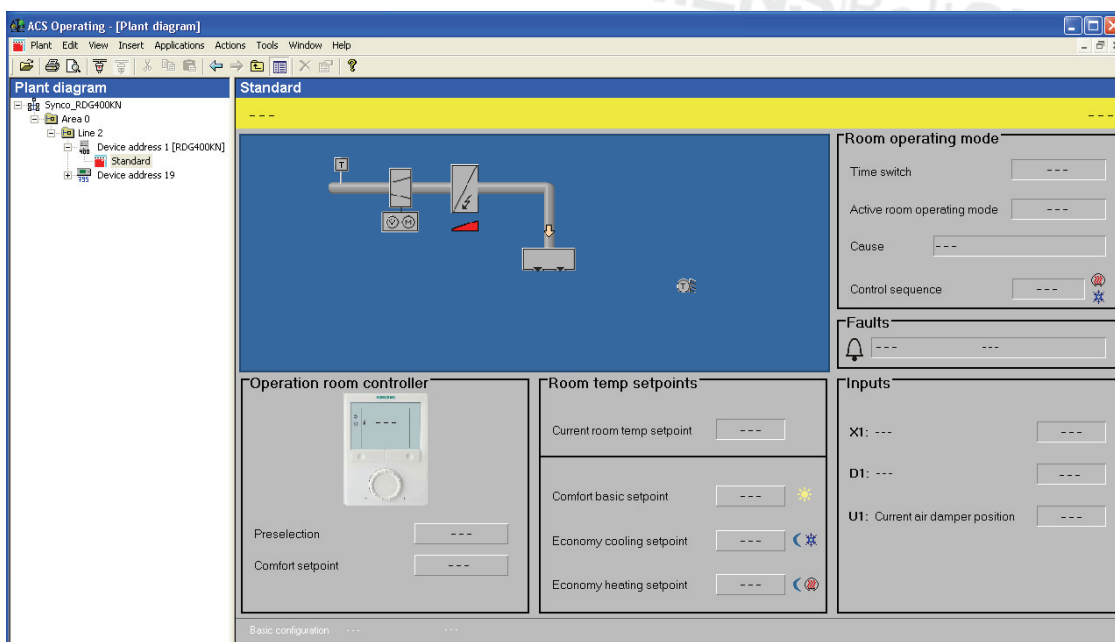

ACS provides standard plant diagrams for RDG KNX thermostats, which depend on the configuration as follows:

Plant type	Application
Single duct	
Single duct with electric heater	
Single duct with radiator	
Single duct with heating / cooling coil	

5.2.3 Operation and monitoring with OZW772

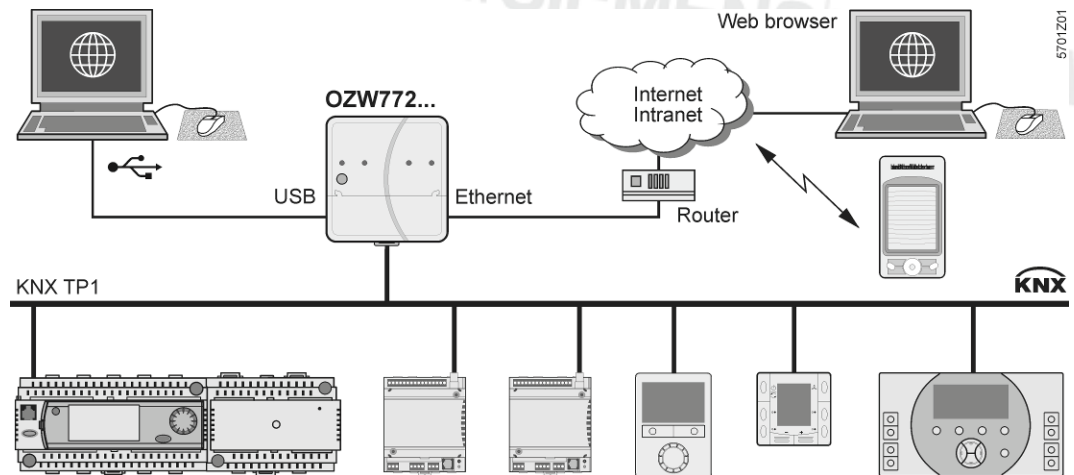

The OZW772 web server enables users to operate a Synco HVAC system from a remote location – via PC or from a smart phone via the web. A start page shows the most important data points. A combination of menu / path navigation enables users to access all data points quickly and straightforwardly. The entire installation can be visualized in the form of plant diagrams. Alarm and state messages can be forwarded to different message receivers, such as e-mail, SMS, etc.

For details, see Commissioning Instructions CE1C5701.

5.2.4 Operation and monitoring with RMZ972



The RMZ972 is a communicating operator unit designed for operating Synco™ 700 and RDG KNX devices in a KNX network.

The operator unit is suited both for fixed installation and mobile use (e.g. for use by the service engineer).

Third-party devices cannot be operated with it.

For details, see Basic Documentation CE1P3113.

Note: The application cannot be displayed in the form of text, instead a number is used: (Parameter **Plant type** on menu **Basic setting**):

- 0 = no application
- 1 = single duct
- 2 = single duct and electric heater
- 3 = single duct and radiator
- 4 = single duct and heating / cooling coil

6. Connection

6.1 Connection terminals

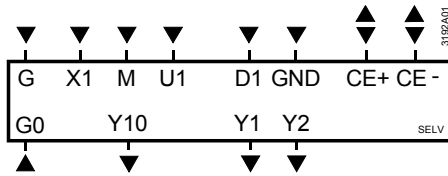

G, G0	Operating voltage AC 24 V
Y10/G0	Control output for DC 0...10 V actuator
Y1/G, Y2/G	Control output for 2-position, PWM or 3-position actuators
X1	Multifunctional input for temperature sensor (e.g. QAH11.1) or potential-free switch Factory setting: external temperature sensor (function can be selected via parameters P38)
M	Measuring neutral for sensors and switches
U1	DC 0...10 V input for actual damper position (Note: G0 is the measuring neutral for U1!)
D1, GND	Multifunctional input for potential-free switch. Factory setting: Operating mode switchover contact (function can be selected via parameters P42)
CE+	KNX data +
CE-	KNX data -

6.2 Connection diagrams

Application

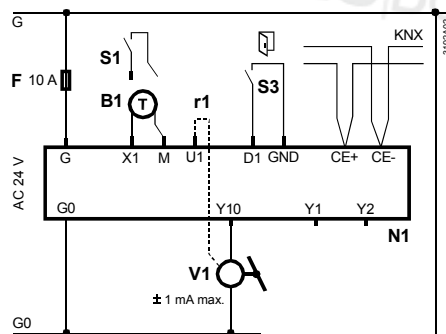

Single duct

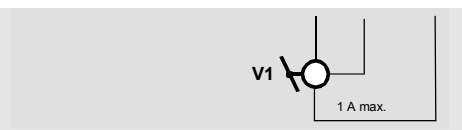

Single-duct with electric heater, radiator or heating / cooling valve

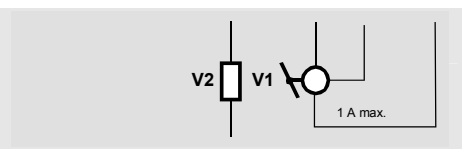
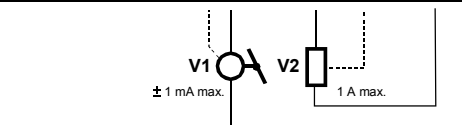

N1	Room thermostat RDG400KN
V1	Damper actuator or VAV compact controller: DC 0...10 V or 3-position
V2	Electric heater, radiator or heating / cooling valve: DC 0...10 V, 2-position, PWM or 3-position
S1	Switch (keycard, window contact, etc.)
r1	Feedback signal for actual damper position
S3	Switch at SELV input (keycard, window contact)
B1	Temperature sensor (return air temperature, external room temperature, changeover sensor, etc.)
CE+	KNX data +
CE-	KNX data -

7. Mechanical design

7.1 General

The room thermostat consists of 2 parts:

- Plastic housing with electronics, operating elements and room temperature sensor
- Mounting plate with the screw terminals

The housing engages in the mounting plate and is secured with 2 screws.

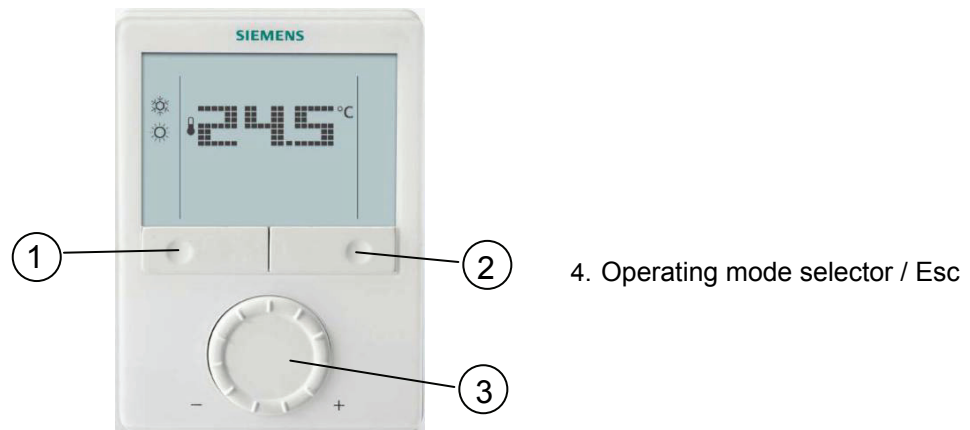

4. Operating mode selector / Esc

For operation, refer to section 4.3.

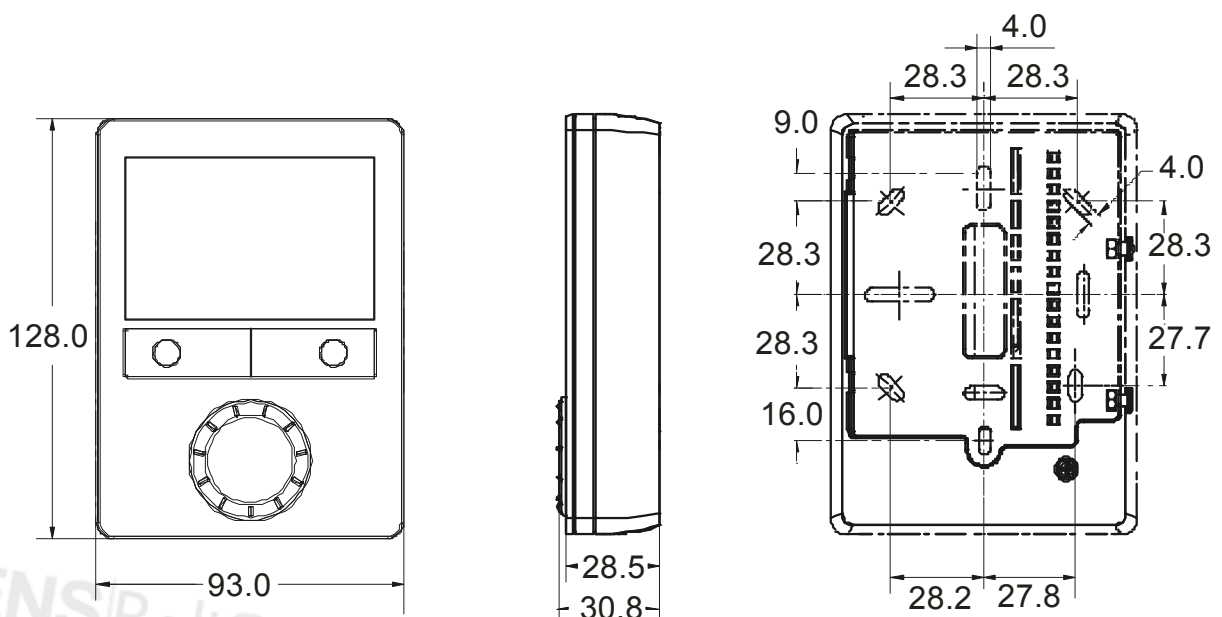

7.2 Dimensions

Dimensions in mm



8. Technical data

⚠ Power supply	Operating voltage	SELV AC 24 V ±20%
	Frequency	50/60 Hz
	Power consumption	Max. 2 VA / 1 W
Outputs	Control output Y10-G0	DC 0...10 V
	Resolution	39 mV
	Current	Max. ±1 mA
	Control output Y1, Y2-G	AC 24 V
Inputs	Rating	Max. 1 A
	Multifunctional inputs X1-M	
	Temperature sensor input	
	Type	QAH11.1 (NTC)
	Digital input	
	Operating action	Selectable (NO/NC)
	Contact sensing	DC 0...5 V, max. 5 mA
	U1-G0	
	Input for actual damper position feedback	
	damper position 0% (fully closed)	DC 0...10 V, max 0.3 mA
	100% (fully open)	DC 0...10 V, max 0.3 mA
	D1-GND	Selectable (NO/NC)
	Operating action	SELV DC 6...15 V, 3...6 mA
	Contact sensing	
Function of inputs	Selectable	
External temperature sensor, heating/cooling changeover sensor, operating mode switchover contact, dewpoint monitor contact, enable electric heater contact, fault contact, monitoring input	X1: P38 D1: P42	
KNX bus	Interface type	KNX, TP1-64 (electrically isolated)
	Bus current	20 mA
	Bus topology:	See KNX manual (reference documentation, see below)
Operational data	Switching differential, adjustable	
	Heating mode (P30)	2 K (0.5...6 K)
	Cooling mode (P31)	1 K (0.5...6 K)
	Setpoint setting and setpoint range	
	☀ Comfort (P08)	21 °C (5...40 °C)
	☾ Economy (P11-P12)	15 °C/30 °C (OFF, 5...40 °C)
	⊕ Protection (P65-P66)	8 °C/OFF (OFF, 5...40 °C)
	Multifunctional inputs X1 / D1	Selectable (0...8)
	Input X1 default value (P38)	1 (Ext. temperature sensor, room or return air)
	Input D1 default value (P42)	3 (Operating mode switchover)
	Built-in room temperature sensor	
	Measuring range	0...49 °C
	Accuracy at 25 °C	< ± 0.5 K
	Temperature calibration range	± 3.0 K
Settings and display resolution		

Environmental conditions	Setpoints	0.5 °C
	Current temperature value displayed	0.5 °C
	Operation	IEC 721-3-3
	Climatic conditions	Class 3K5
	Temperature	0...50 °C
	Humidity	<95% r.h.
	Transport	IEC 721-3-2
	Climatic conditions	Class 2K3
	Temperature	-25... 60 °C
	Humidity	<95% r.h.
Standards and directives	Mechanical conditions	Class 2M2
	Storage	IEC 721-3-1
	Climatic conditions	Class 1K3
	Temperature	-25... 60 °C
	Humidity	<95% r.h.
	 conformity to EMC directive	2004/108/EC
	 C-tick conformity to EMC emission standard	AS/NZS 61000.6.3: 2007
	 Reduction of hazardous substances	2002/95/EG
	Product standards	
	Automatic electrical controls for household and similar use	EN 60730-1
Special requirements for temperature-dependent controls	EN 60730-2-9	
Electronic control type	2.B (micro-disconnection on operation)	
Home and Building Electronic Systems	EN 50090-2-2	
General	Electromagnetic compatibility	
	Emissions (residential)	IEC/EN 61000-6-3
	Immunity (Industry and residential)	IEC/EN 61000-6-2
	Safety class	III as per EN 60730
	Pollution class	Normal
	Degree of protection of housing	IP30 as per EN 60529
	Connection terminals	Solid wires or stranded wires with wire end sleeves 1 x 0.4...2.5 mm ² or 2 x 0.4...1.5 mm ²
	Housing front color	RAL 9003 white
	Weight without / with packaging	0.237 kg / 0.360 kg

Index

3		
3-position control signal	40	
3-position for air flow	40	
A		
Absence	17	
Air demand	50	
Air heating / cooling changeover	25	
Applications overview	24	
Auto Timer mode	16	
Automatic heating / cooling changeover	25	
Automatic heating / cooling changeover via bus ..	25	
B		
Button lock	27	
C		
Changeover switch	26	
Control output VAV	50	
Control outputs configuration	43	
Control outputs overview	40	
Control parameters	57	
Control sequences	28	
Cooling demand	50	
D		
DC 0 ... 10 V control signal	40	
DC 0 ... 10 V for air flow	40	
DC 0...10 V for el. heaters	41	
Dew point monitoring	27, 44	
Digital input	44	
Disposal	67	
E		
Effect of Protection via time schedule	16	
Electric heater	33	
Enable / disable electric heater	45	
Enable/disable electrical heater	33	
Expert level parameters	57	
Extension of Comfort mode	17	
Extension of presence / absence	17	
External / return air temperature	44	
External / return air temperature sensor	26	
F		
Fault	45	
Fault on KNX	52	
Fault, handling	46	
Floor temperature limitation function	26	
H		
Heating / cooling changeover	44	
Heating demand	50	
I		
Integral action time	13	
M		
Mounting and installation	62	
Multifunctional inputs	44	
O		
ON/OFF control signal	40	
Operating mode		
Priority intervention	15	
Operating mode button	16	
Operating mode switchover	44	
P		
Parameter setting	57	
Precomfort	16	
Presence	17	
Proportional band	13	
Protection mode / Standby	14	
PWM	40	
PWM for electric heaters	42	
R		
Radiator	35	
Remote heating / cooling changeover	26	
Reset parameters	57	
S		
Sensor input	44	
Service level parameters	57	
Setpoint Comfort mode	39	
Setpoint Economy mode	39	
Setpoint limitation	21	
Setpoint Protection mode	39	
Setpoints and sequences	39	
Standby / Protection mode	14	
Supply air temperature	25	
Switching differential	13	
Synchronization	40, 42	
T		
Temperature out of range	46	
Temporary setpoint	21	
Time schedule change mode	16	

V
VAV changeover 25
VAV changeover via bus 28

W
Window contact 16
Window state 14, 15, 44

Siemens Switzerland Ltd
Industry Sector
Building Technologies Division
International Headquarters
Gubelstrasse 22
CH-6301 Zug
Tel. +41 41-724 24 24
www.buildingtechnologies.siemens.com

© 2010 Siemens Switzerland Ltd
Subject to change